

FTC (Side Outlet) Standard Custom Form

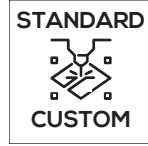

FT (Side outlet) linear drains are designed for use with liquid applied (cold fluid applied) or fabric sheet membranes. The overall inside length of channel (**A**) is the finished length of the drain, with a 1-1/16" flange on all four sides to accept the waterproofing membrane. All outlet locations (**B**) are measured from the right inside channel edge. For this type of installation a mortar bed or equal is created up to and around the drain with the appropriate slope towards the drain. The waterproofing is applied over the mortar bed and the flange of the channel. Tile or stone is applied directly to the waterproofing for a low profile installation.

Specialty channel options are available.

- **OCS** for Schuler®-KERDI Waterproofing - KERDI membrane factory applied to the side outlet channel. Uses a 2" No-Hub Outlet.
- **OCH** for Threaded Connection - This channel is provided with a 2" male tapered thread (MPT) for direct threaded connection to a female threaded pipe.

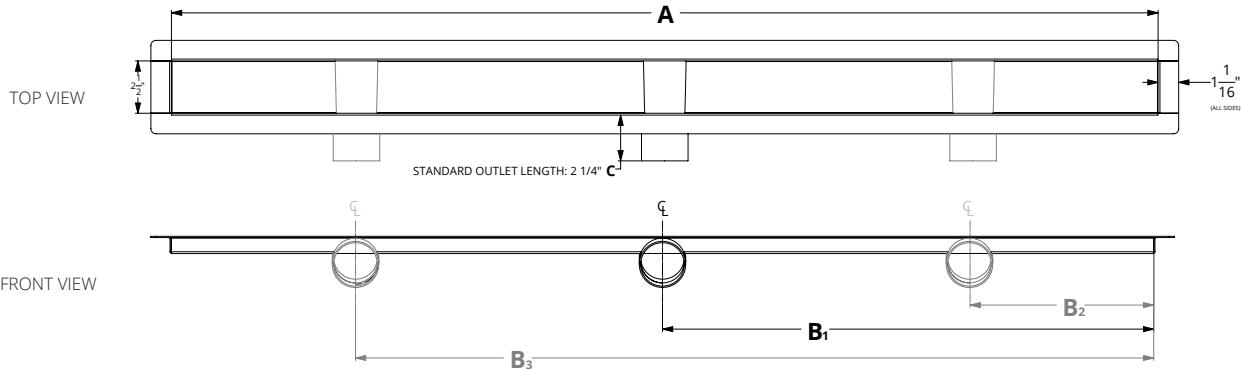

A: Overall Inside Length	B1: Outlet Location 1	B2: Outlet Location 2	B3: Outlet Location 3	C: Outlet Length
<input type="checkbox"/>	<input type="checkbox"/>	<input type="checkbox"/>	<input type="checkbox"/>	<input type="checkbox"/>
FOR ADDITIONAL OUTLETS IF NEEDED				IF NOT STANDARD

Channel Option: Choose (1)

FT Standard (OC 65 Channel)
2" No Hub Outlet

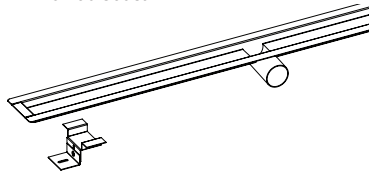

OCS Standard
Factory applied KERDI - 2" No Hub Outlet

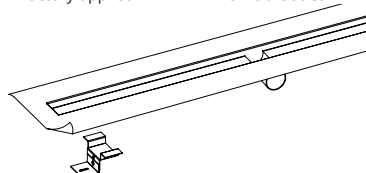

OCH Tapered Threaded
2" MPT Outlet

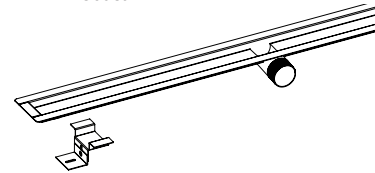

Note: Lengths exceeding the grate's maximum single length will be split into equal sections.

Grate Styles - Choose (1) Below		OR	Channel Only <input type="checkbox"/>
FTAS 25 1" WIDE <input type="checkbox"/> WEDGE WIRE SA 25 GRATE Maximum Single Grate Length: 72"		FTSG 65 SOLID GRATE SG 65 GRATE Maximum Single Grate Length: 60"	
FTAS 38 1 1/2" WIDE <input type="checkbox"/> WEDGE WIRE SA 38 GRATE Maximum Single Grate Length: 72"		FTD 65 OFFSET OVAL PATTERN EA 65 GRATE Maximum Single Grate Length: 96"	
FTAS 65 2 1/2" WIDE <input type="checkbox"/> WEDGE WIRE SA 65 GRATE Maximum Single Grate Length: 72"		FTMN 65 MARC NEWSON PATTERN MA 65 GRATE Maximum Single Grate Length: 96"	
FTTIF 65 TILE INSERT RA 65 GRATE Maximum Single Grate Length: 60"		FTDG 65 CIRCLE PATTERN PA 65 GRATE Maximum Single Grate Length: 96"	
		FTGR 65 ADHESION PATTERN GA 65 GRATE Maximum Single Grate Length: 96"	
		FTIG 65 SLOTTED PATTERN UA 65 GRATE Maximum Single Grate Length: 96"	

Grate Finish - Choose (1)

- Satin Stainless (SS)
- Polished Stainless (PS)
- Oil Rubbed Bronze (ORB)
- Satin Bronze (SB)
- Matte Black (BK)
- Gunmetal
- Matte White
- Satin Champagne
- Polished Brass
- Polished Gold

Custom Finish
(Specify Color to Match)





Custom finishes can be made to match a sample provided by the customer. Contact Infinity Drain for availability of desired finish.

Terms and Conditions:

By signing this form, you are agreeing to the terms and conditions herein. All details and finishes stated are correct. All dimensions are correct and are to be held within a tolerance of +/- 1/16". All other details and dimensions that are specified as "standard" are subject to manufacturer's tolerance and change without notice. We can assume no responsibility for use of superceded or void data. All custom orders are non-cancellable, non-returnable and non-refundable.

Infinity Drain
145 Dixon Avenue
Amityville, NY 11701
Phone: 516.767.6786
Fax: 516.740.3066
www.infinitydrain.com

APPROVAL	NAME <input type="checkbox"/>	JOB NAME/REFERENCE <input type="checkbox"/>
	SIGNATURE <input type="checkbox"/>	DATE <input type="checkbox"/>

FM524-12-23

For pricing email: quotes@infinitydrain.com