

FXAS 38 Fixed Length Series

- **FXAS 3832 - 32" Complete Kit**
- **FXAS 3836 - 36" Complete Kit**
- **FXAS 3842 - 42" Complete Kit**
- **FXAS 3848 - 48" Complete Kit**
- **FXAS 3860 - 60" Complete Kit**

Features

- Pre-pitched channel with fixed lengths and fixed center outlet
- Indoor or outdoor use
- 16 gauge, 304L Stainless steel channel
- 12 gauge 316L stainless steel Wedge Wire grate
- Works with 2" clamp down floor drain with 2" throat/strainer size (*NOT included*)
- Compatible with: PVC Liner, Rubber Liner (Chloraloy®), Hot Mop, Lead Pan, Copper Pan, or Fiberglass
- Grate can be removed completely for cleaning
- Flow rate - 9 gpm per outlet
 - Flow rate measured at outlet only. Measurement does not account for water in channel or sheeting on shower floor.

Installation

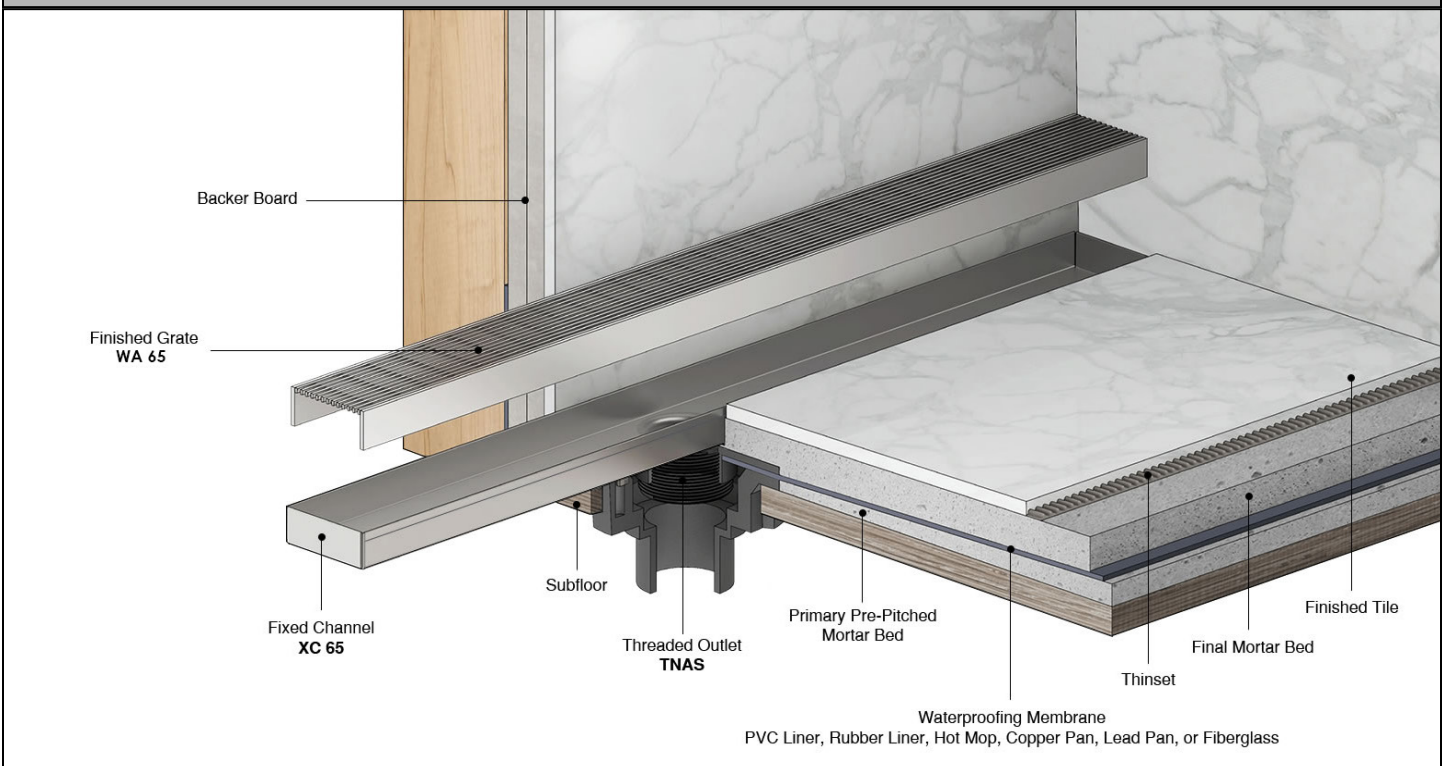

Care & Maintenance

FXAS 38 stainless steel linear drain top grates are made of 316L stainless steel. This material is non-porous, hygienic, rust-free and extremely durable. Bar Keepers Friend® and Soft Scrub® are commonly available products that can be used to protect and clean your Satin Stainless drain cover. For stains that have been left for an excessive amount of time, stronger cleaning agents such as Steel Brite® may be needed. For all finishes we recommend using mild soap and a soft cloth for cleaning. DO NOT use any abrasive cleaners, scrub pads or allow household cleaning agents, such as bleach, to sit on the drain cover for a long period of time. Stainless steel does not rust. External factors, such as contamination from other highly ferrous metals, built up road salt, sea salt, or chlorine may have caused "surface" rust which can be removed using Barkeepers Friend®, Soft Scrub®, or Steel Brite Cleaner. Always follow the directions on the bottle. Follow proper maintenance procedures to prevent excessive surface rust. In areas of frequent exposure to salt, chlorine, and other chemical compounds, maintenance of the stainless grates should be performed at least 2-3 times per year.

Infinity Drain
145 Dixon Avenue
Amityville, NY 11701
Phone: 516.767.6786
Fax: 516.740.3066
www.Infinitydrain.com

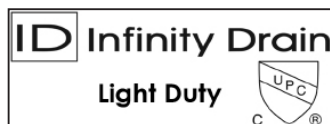

NOTE: Installer must verify all rough-in dimensions prior to installation and consult local and national codes. Conformity and compliance to local and national codes are the responsibility of the installer.

ID Infinity Drain®

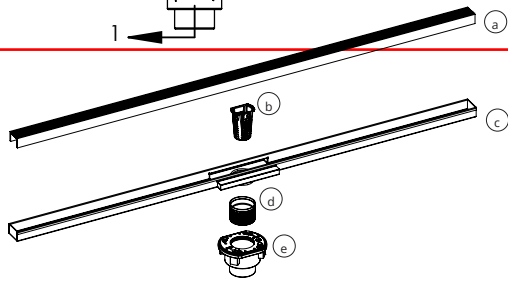
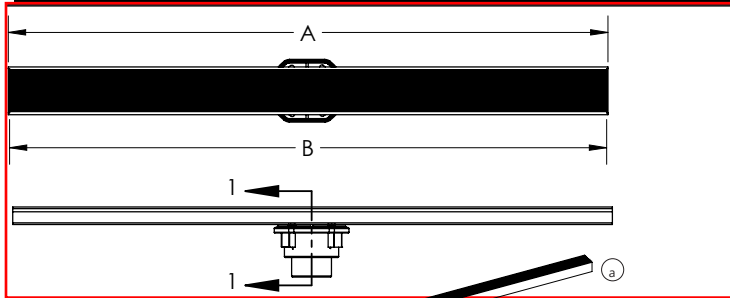

- (a) SA 38 - Wedge Wire Grate
- (b) HB 32 - Hair Basket
- (c) XC 38 - Stainless Steel Channel
- (d) TNAS - Threaded Nipple
- (e) 2 inch clamp down drain assembly
Not included in kit SKU.

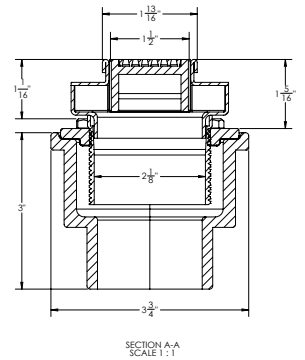

SECTION 1-1

Model Number	Complete Kit Contents	A (Maximum Overall Length)	B (Maximum Grate Length)
FXAS 3832	1 - SA 3832 Grate 1 - XC 3832 Fixed Channel 1 - TNAS Threaded Nipple 1 - HMK-38-A: 1 HB 32 Hair Basket 1 AKEY Lift Out Key	32 1/8"	31 7/8"
FXAS 3836	1 - SA 3836 Grate 1 - XC 3836 Fixed Channel 1 - TNAS Threaded Nipple 1 - HMK-38-A: 1 HB 32 Hair Basket 1 AKEY Lift Out Key	36 1/8"	35 7/8"
FXAS 3842	1 - SA 3842 Grate 1 - XC 3842 Fixed Channel 1 - TNAS Threaded Nipple 1 - HMK-38-A: 1 HB 32 Hair Basket 1 AKEY Lift Out Key	42 1/8"	41 7/8"
FXAS 3848	1 - SA 3848 Grate 1 - XC 3848 Fixed Channel 1 - TNAS Threaded Nipple 1 - HMK-38-A: 1 HB 32 Hair Basket 1 AKEY Lift Out Key	48 1/8"	47 7/8"
FXAS 3860	1 - SA 3860 Grate 1 - XC 3860 Fixed Channel 1 - TNAS Threaded Nipple 1 - HMK-38-A: 1 HB 32 Hair Basket 1 AKEY Lift Out Key	60 1/8"	59 7/8"

Finishes

- Satin Stainless (SS)
- Polished Stainless (PS)
- Oil Rubbed Bronze (ORB)
- Satin Bronze (SB)
- Matte Black (BK)
- Satin Champagne (SC)
- Polished Gold (PG)
- Polished Brass (PB)
- Gunmetal (GM)
- Matte White (MW)

Infinity Drain
145 Dixon Avenue
Amityville, NY 11701
Phone: 516.767.6786
Fax: 516.740.3066
www.Infinitydrain.com



NOTE: Installer must verify all rough-in dimensions prior to installation and consult local and national codes. Conformity and compliance to local and national codes are the responsibility of the installer.

OPTIONAL COMPONENTS

CDI 22 / CDA 22 / CDP 22	Clamp Down Drain Body Assembly in Cast Iron , or ABS , PVC with 2" Throat, 2" No Hub Outlet.
TNAS - 2 / TNAS -3 / TNAS -4	2" Long Threaded Nipple, 3" Long Threaded Nipple 4" Long Threaded Nipple
TNRN -S	Stainless Steel Extension Nipple
TNRN-P	PVC Extension Nipple
UCP 2	Universal 2" Clamping Plate
UCP 42	Universal Reducing Plate (Adapts 4" or 3" existing throat size to 2")
CDIT 22	Clamp Down Drain, Cast Iron , 2" Throat, 2" Threaded Outlet
CDIC 22	Clamp Down Drain, Cast Iron , 2" Throat, 2" Inside Caulk Outlet
CDIS 22	Clamp Down Drain, Cast Iron , Integral Trap 2" Throat, 2" Threaded Side Outlet
CDIQ 42	Clamp Down Drain, Cast Iron , Side Outlet No Trap 4" Throat, 2" Outlet (For use with UCP 42)

CUSTOM FIXED LENGTH SERIES DRAINS



NEW Next Day Custom

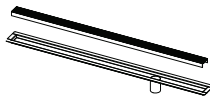

- Purchase orders and sign offs received by 10am ET will ship the following day
- Completed custom form must accompany purchase order
- Straight configuration and custom lengths up to 96"
- Grate Styles: Wedge Wire, Offset Slotted, Tile Insert Frame
- Installation types: Fixed (FX)
- Custom outlet placement for multiple outlets
- Finishes: Satin Stainless, Polished Stainless, Oil Rubbed Bronze, Satin Bronze and Matte Black

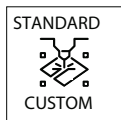

Standard Custom

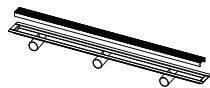

- Purchase orders and sign offs received by 10am ET will ship within 15 business days
- Completed custom form must accompany purchase order
- Straight configuration and custom lengths up to 96"
- Any standard grate style options
- Installation types: Fixed (FX)
- Custom outlet placement for multiple outlets
- Finishes: Satin Stainless, Polished Stainless, Oil Rubbed Bronze, Satin Bronze and Matte Black

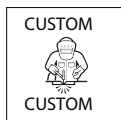

Custom-Custom

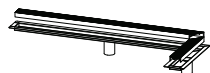

- Specialty installation options (Sink drain, Elevator drain, Threshold drain, Vinyl Clamp drain, etc.)
- Any shape and configuration
- Any installation type
- Any outlet type
- Any finish. Standard finishes and color match finish options available.

[CLICK HERE - TO LEARN MORE ABOUT CUSTOM FABRICATION](#)

For additional information regarding Custom Fabrication, Please contact Technical Support at info@infinitydrain.com

Infinity Drain
145 Dixon Avenue
Amityville, NY 11701
Phone: 516.767.6786
Fax: 516.740.3066
www.infinitydrain.com



NOTE: Installer must verify all rough-in dimensions prior to installation and consult local and national codes. Conformity and compliance to local and national codes are the responsibility of the installer.