



FXTIF 65 Fixed Length Series

- FXTIF 6524 - 24" Complete Kit
- FXTIF 6532 - 32" Complete Kit
- FXTIF 6536 - 36" Complete Kit
- FXTIF 6542 - 42" Complete Kit
- FXTIF 6548 - 48" Complete Kit
- FXTIF 6560 - 60" Complete Kit

Features

- Pre-pitched channel with fixed lengths and fixed center outlet
- Indoor or outdoor use
- 16 gauge, 304L stainless steel channel
- 12 gauge, 304L stainless steel Tile Insert Frame for 3/4" Tile
- Works with 2" clamp down floor with 2" throat/strainer size *(NOT included)*
- Compatible with: PVC Liner, Rubber Liner (Chloraloy®), Hot Mop, Lead Pan, Copper Pan, or Fiberglass
- Grate can be removed completely for cleaning
- Flow rate - 9 gpm per outlet
 - Flow rate measured at outlet only. Measurement does not account for water in channel or sheeting on shower floor.

Installation

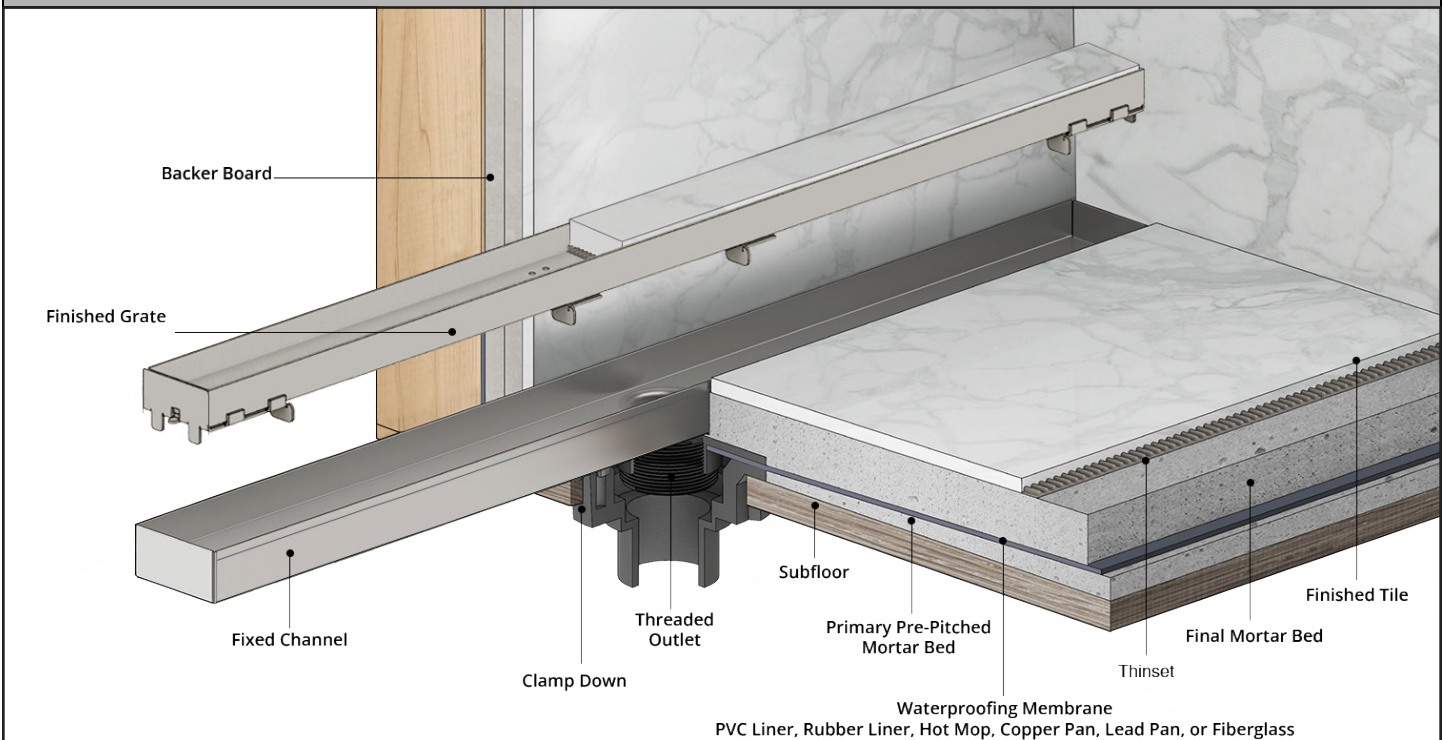

Care & Maintenance

FXTIF 65 stainless steel linear drain top grates are made of 304L stainless steel. This material is non-porous, hygienic, rust-free and extremely durable. Bar Keepers Friend® and Soft Scrub® are commonly available products that can be used to protect and clean your Satin Stainless drain cover. For stains that have been left for an excessive amount of time, stronger cleaning agents such as Steel Brite® may be needed. For all finishes we recommend using mild soap and a soft cloth for cleaning. DO NOT use any abrasive cleaners, scrub pads or allow household cleaning agents, such as bleach, to sit on the dTAin cover for a long period of time. Stainless steel does not rust. External factors, such as contamination from other highly ferrous metals, built up road salt, sea salt, or chlorine may have caused "surface" rust which can be removed using Barkeepers Friend®, Soft Scrub®, or Steel Brite Cleaner. Always follow the directions on the bottle. Follow proper maintenance procedures to prevent excessive surface rust. In areas of frequent exposure to salt, chlorine, and other chemical compounds, maintenance of the stainless grates should be performed at least 2-3 times per year.

Infinity Drain
145 Dixon Avenue
Amityville, NY 11701
Phone: 516.767.6786
Fax: 516.740.3066
www.InfinitydTAin.com



NOTE: Installer must verify all rough-in dimensions prior to installation and consult local and national codes. Conformity and compliance to local and national codes are the responsibility of the installer.

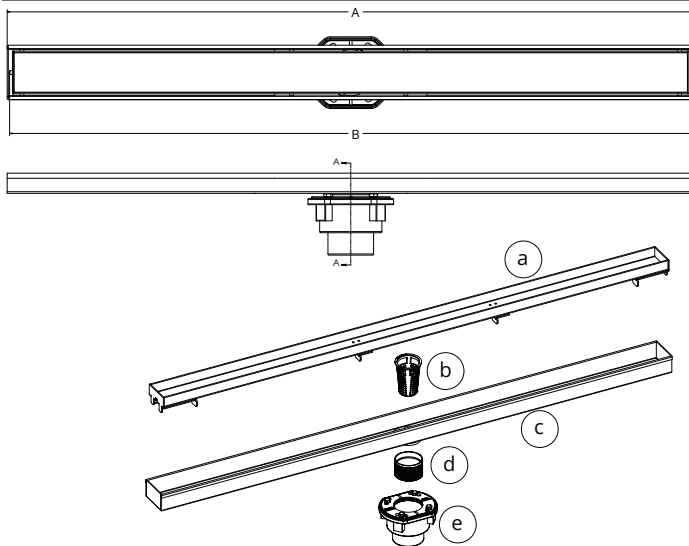

- Ⓐ TA 65 - Stainless Steel Tile Insert Assembly
- Ⓑ HB 65 - Hair Basket
- Ⓒ IC 65 - Stainless Steel Channel
- Ⓓ TNAS - Threaded Nipple
- Ⓔ 2 inch clamp down drain assembly
Not included in kit SKU.
(Material can be Cast Iron, ABS, or PVC)

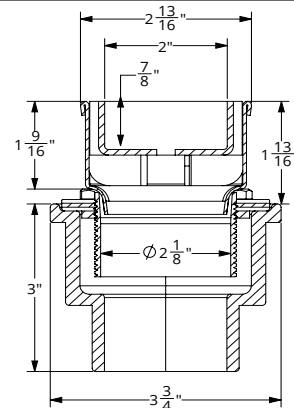

SECTION A-A

| Model Number | Complete Kit Contents | A (Maximum OverTAlL Length) | B (Maximum GTate Length) |
|-------------------------------------|---|--------------------------------|-----------------------------|
| <input type="checkbox"/> FXTIF 6524 | 1 - TA 6524 Tile Insert Frame 1 - XC 6524 Fixed Channel 1 - TNAS Threaded Nipple 1 - HMK-65-A: 1 HB 65 Hair Basket 1 AKEY Lift Out Key | 24 1/8" | 23 7/8" |
| <input type="checkbox"/> FXTIF 6532 | 1 - TA 6532 Tile Insert Frame 1 - XC 6532 Fixed Channel 1 - TNAS Threaded Nipple 1 - HMK-65-A: 1 HB 65 Hair Basket 1 AKEY Lift Out Key | 32 1/8" | 31 7/8" |
| <input type="checkbox"/> FXTIF 6536 | 1 - TA 6536 Tile Insert Frame 1 - XC 6536 Fixed Channel 1 - TNAS Threaded Nipple 1 - HMK-65-A: 1 HB 65 Hair Basket 1 AKEY Lift Out Key | 36 1/8" | 35 7/8" |
| <input type="checkbox"/> FXTIF 6542 | 1 - TA 6542 Tile Insert Frame 1 - XC 6542 Fixed Channel 1 - TNAS Threaded Nipple 1 - HMK-65-A: 1 HB 65 Hair Basket 1 AKEY Lift Out Key | 42 1/8" | 41 7/8" |
| <input type="checkbox"/> FXTIF 6548 | 1 - TA 6548 Tile Insert Frame 1 - XC 6548 Fixed Channel 1 - TNAS Threaded Nipple 1 - HMK-65-A: 1 HB 65 Hair Basket 1 AKEY Lift Out Key | 48 1/8" | 47 7/8" |
| <input type="checkbox"/> FXTIF 6560 | 1 - TA 6560 Tile Insert Frame 1 - XC 6560 Fixed Channel 1 - TNAS Threaded Nipple 1 - HMK-65-A: 1 HB 65 Hair Basket 1 AKEY Lift Out Key | 60 1/8" | 59 7/8" |

Finishes

- Satin Stainless (SS) Polished Stainless (PS) Oil Rubbed Bronze (ORB) Satin Bronze (SB) Matte Black (BK)

Infinity Drain
145 Dixon Avenue
Amityville, NY 11701
Phone: 516.767.6786
Fax: 516.740.3066
www.InfinityDrain.com



NOTE: Installer must verify all rough-in dimensions prior to installation and consult local and national codes. Conformity and compliance to local and national codes are the responsibility of the installer.

OPTIONAL COMPONENTS

| | |
|------------------------------|---|
| CDI 22 / CDA 22 / CDP 22 | Clamp Down DTain Body Assembly in Cast Iron, or ABS, PVC with 2" Throat, 2" No Hub Outlet. |
| TNAS - 2 / TNAS -3 / TNAS -4 | 2" Long Threaded Nipple, 3" Long Threaded Nipple 4" Long Threaded Nipple |
| TNRN -S | Stainless Steel Extension Nipple |
| TNRN-P | PVC Extension Nipple |
| UCP 2 | Universal 2" Clamping Plate |
| UCP 42 | Universal Reducing Plate (Adapts 4" or 3" existing throat size to 2") |
| CDIT 22 | Clamp Down DTain, Cast Iron, 2" Throat, 2" Threaded Outlet |
| CDIC 22 | Clamp Down DTain, Cast Iron, 2" Throat, 2" Inside Caulk Outlet |
| CDIS 22 | Clamp Down DTain, Cast Iron, IntegTAI TTAp 2" Throat, 2" Threaded Side Outlet |
| CDIQ 42 | Clamp Down DTain, Cast Iron, Side Outlet No TTAp 4" Throat, 2" Outlet (For use with UCP 42) |

CUSTOM FIXED LENGTH SERIES DTAINS



NEW Next Day Custom

- Purchase orders and sign offs received by 10am ET will ship the following day
- Completed custom form must accompany purchase order
- Straight configuration and custom lengths up to 96"
- Grate Styles: Wedge Wire, Offset Slotted, Tile Insert Frame
- Installation types: Fixed (FX)
- Custom outlet placement for multiple outlets
- Finishes: Satin Stainless, Polished Stainless, Oil Rubbed Bronze, Satin Bronze and Matte Black

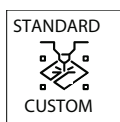
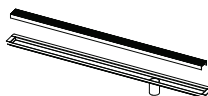

Standard Custom

- Purchase orders and sign offs received by 10am ET will ship within 15 business days
- Completed custom form must accompany purchase order
- Straight configuration and custom lengths up to 96"
- Any standard grate style options
- Installation types: Fixed (FX)
- Custom outlet placement for multiple outlets
- Finishes: Satin Stainless, Polished Stainless, Oil Rubbed Bronze, Satin Bronze and Matte Black

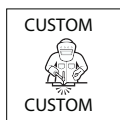
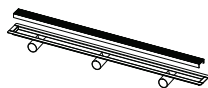

Custom-Custom

- Specialty installation options (Sink drain, Elevator drain, Threshold drain, Vinyl Clamp drain, etc.)
- Any shape and configuration
- Any installation type
- Any outlet type
- Any finish. Standard finishes and color match finish options available.

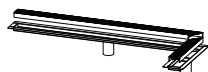

[CLICK HERE - TO LEARN MORE ABOUT CUSTOM FABRICATION](#)

For additional information regarding Custom Fabrication, Please contact Technical Support at info@infinitydTAin.com

Infinity Drain
145 Dixon Avenue
Amityville, NY 11701
Phone: 516.767.6786
Fax: 516.740.3066



NOTE: Installer must verify all rough-in dimensions prior to installation and consult local and national codes. Conformity and compliance to local and national codes are the responsibility of the installer.