

BA 65 Specifications

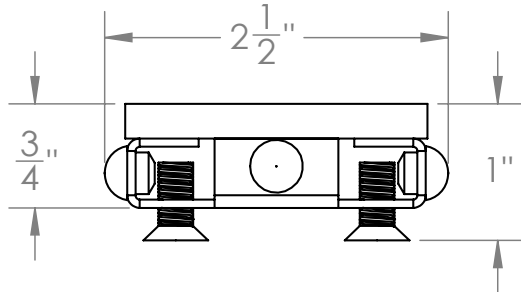

BA 65:

- Solid grate for FXSG 65, FFSG 65, FCSSG 65, FCBSG 65, FTSG 65
- 7 gauge, 304L stainless steel

Models (overall dimensions):

- BA 6532: $31\frac{7}{8}$ " L x $2\frac{1}{2}$ " W x $\frac{3}{4}$ " H
- BA 6536: $35\frac{7}{8}$ " L x $2\frac{1}{2}$ " W x $\frac{3}{4}$ " H
- BA 6542: $41\frac{7}{8}$ " L x $2\frac{1}{2}$ " W x $\frac{3}{4}$ " H
- BA 6548: $47\frac{7}{8}$ " L x $2\frac{1}{2}$ " W x $\frac{3}{4}$ " H
- BA 6560: $59\frac{7}{8}$ " L x $2\frac{1}{2}$ " W x $\frac{3}{4}$ " H

Finishes:

- Satin Stainless - SS
- Polished Stainless - PS
- Satin Bronze - SB
- Oil Rubbed Bronze - ORB
- Matte Black - BK

Specialty Finishes:

- Gunmetal
- Matte White
- Satin Champagne
- Polished Brass
- Polished Gold

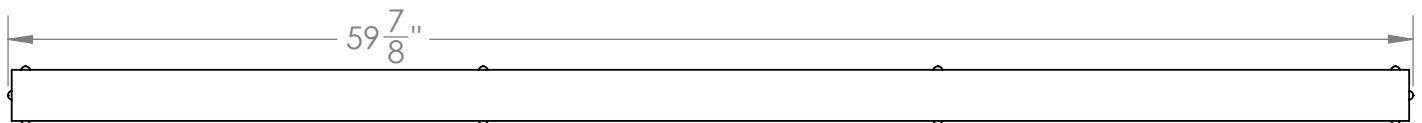
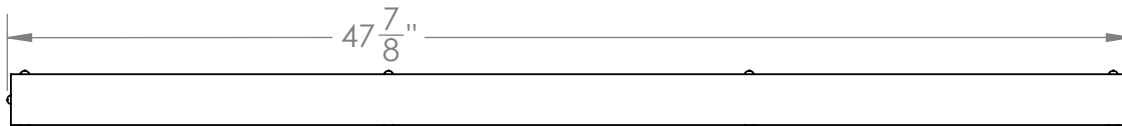
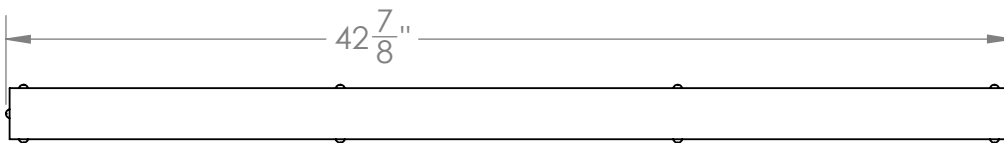
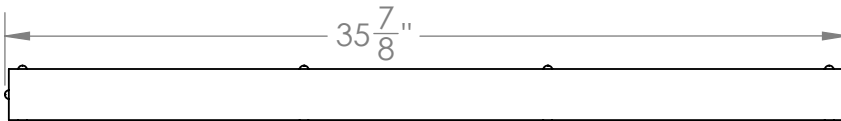
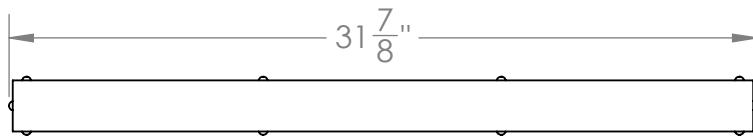
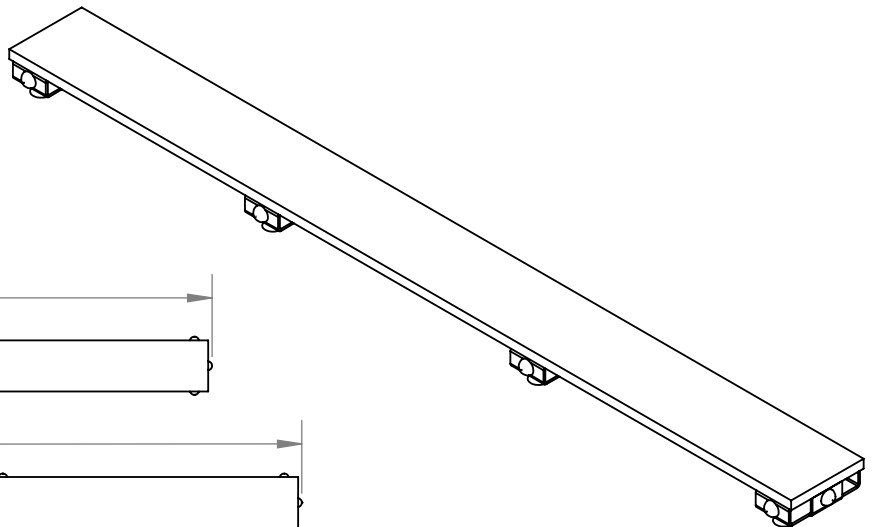

Infinity Drain
145 Dixon Avenue
Amityville, NY 11701
Phone: 516.767.6786
Fax: 516.740.3066
www.infinitydrain.com



NOTE: Installer must verify all rough-in dimensions prior to installation and consult local and national codes. Conformity and compliance to local and national codes are the responsibility of the installer.