

## FCSAS 125

### Flange with Schluter®-Kerdi Series

- FCSAS 12532 - 32" Complete Kit
- FCSAS 12536 - 36" Complete Kit
- FCSAS 12542 - 42" Complete Kit
- FCSAS 12548 - 48" Complete Kit
- FCSAS 12560 - 60" Complete Kit

#### Features

- FCS series linear drains are compliant with Schluter®-Kerdi shower system warranty. Warranty back by Infinity Drain.
- Channel provided with factory applied Schluter®-KERDI
- Indoor or outdoor use
- 12 gauge, 316L stainless steel grate
- 16 gauge, 304L stainless steel channel
- Pre - pitched channel
- Grate can be removed for cleaning
- NOT Site Sizable®
- Compatible with: liquid applied or fabric sheet membranes
- Flow rate - 21 gpm per outlet
  - Flow rate measured at outlet only. Measurement does not account for water in channel or sheeting on shower floor.
  - Additional outlets can be added and combined into a larger waste line to increase flow rates

#### Installation

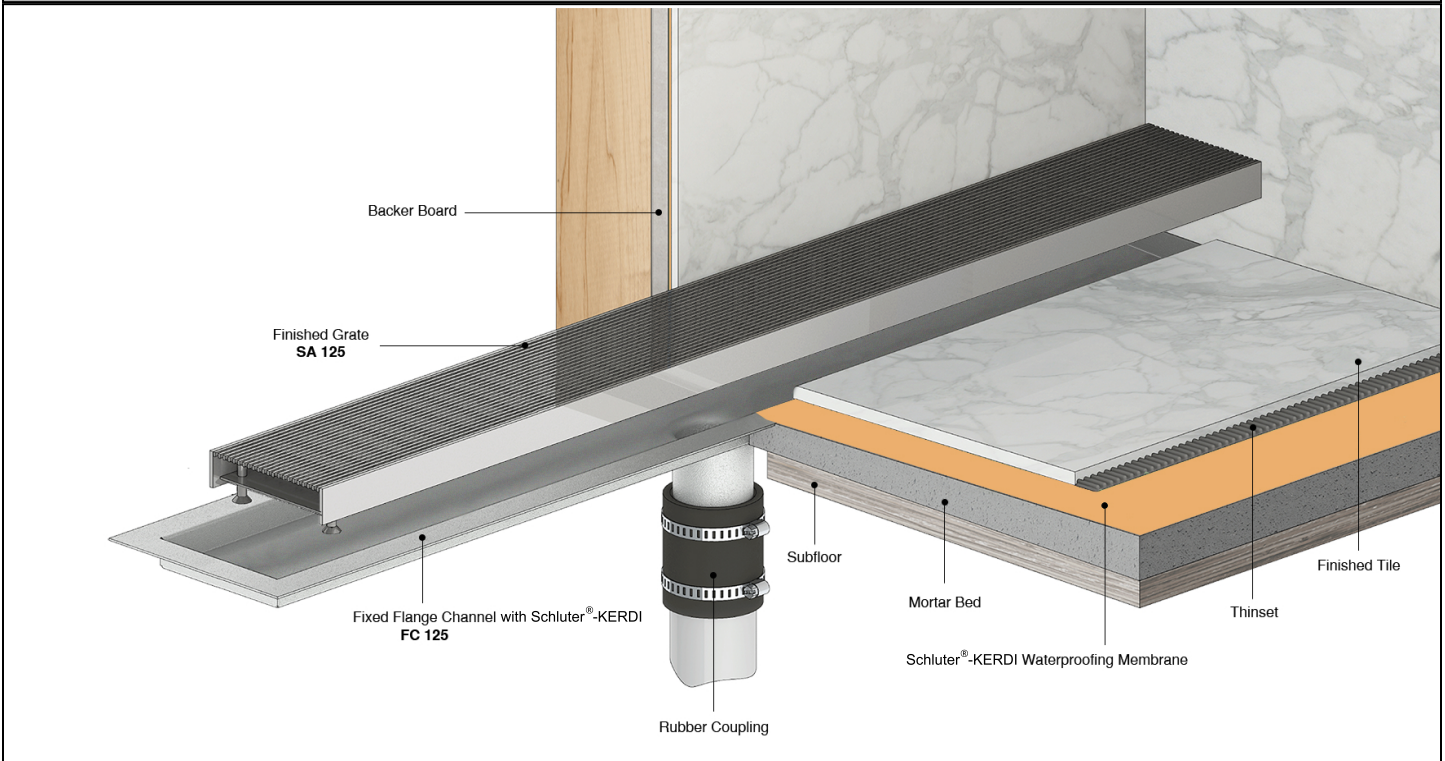

#### Care & Maintenance

FCSAS 125 stainless steel linear drain top grates are made of 316L stainless steel. This material is non-porous, hygienic, rust-free and extremely durable. Bar Keepers Friend® and Soft Scrub® are commonly available products that can be used to protect and clean your Satin Stainless drain cover. For stains that have been left for an excessive amount of time, stronger cleaning agents such as Steel Brite® may be needed. For all finishes we recommend using mild soap and a soft cloth for cleaning. DO NOT use any abrasive cleaners, scrub pads or allow household cleaning agents, such as bleach, to sit on the drain cover for a long period of time. Stainless steel does not rust. External factors, such as contamination from other highly ferrous metals, built up road salt, sea salt, or chlorine may have caused "surface" rust which can be removed using Barkeepers Friend®, Soft Scrub®, or Steel Brite Cleaner. Always follow the directions on the bottle. Follow proper maintenance procedures to prevent excessive surface rust. In areas of frequent exposure to salt, chlorine, and other chemical compounds, maintenance of the stainless grates should be performed at least 2-3 times per year.

**Infinity Drain**  
 145 Dixon Avenue  
 Amityville, NY 11701  
 Phone: 516.767.6786  
 Fax: 516.740.3066  
 www.infinitydrain.com



NOTE: Installer must verify all rough-in dimensions prior to installation and consult local and national codes. Conformity and compliance to local and national codes are the responsibility of the installer.

# ID Infinity Drain®

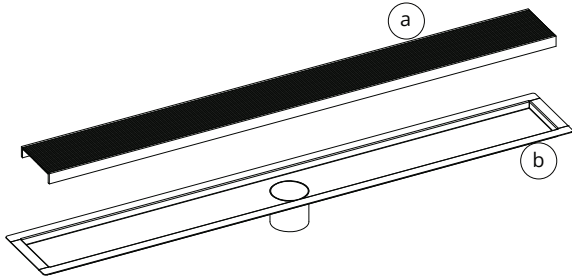
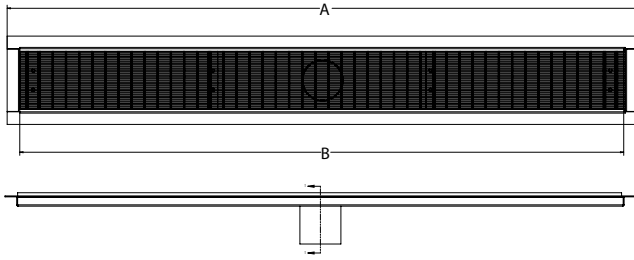

- Ⓐ SA 125 - Stainless Steel Grate
- Ⓑ FC 125 - Stainless Steel Channel

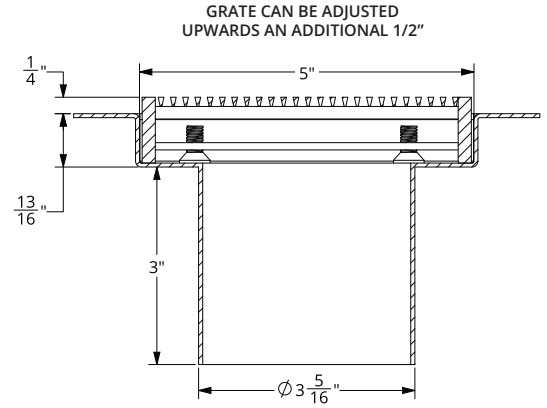

**SECTION 1-1**

Model Number	Complete Kit Contents	A (Maximum Overall Length)	B (Maximum Grate Length)
<input type="checkbox"/> FCSAS 12532	1 - SA 12532 Grate 1 - FC 12532 Fixed Flange Channel with Schluter®-KERDI 1 - HMK-A: 1 AKEY Lift Out Key	34 1/8"	31 7/8"
<input type="checkbox"/> FCSAS 12536	1 - SA 12536 Grate 1 - FC 12536 Fixed Flange Channel with Schluter®-KERDI 1 - HMK-A: 1 AKEY Lift Out Key	38 1/8"	35 7/8"
<input type="checkbox"/> FCSAS 12542	1 - SA 12542 Grate 1 - FC 12542 Fixed Flange Channel with Schluter®-KERDI 1 - HMK-A: 1 AKEY Lift Out Key	44 1/8"	41 7/8"
<input type="checkbox"/> FCSAS 12548	1 - SA 12548 Grate 1 - FC 12548 Fixed Flange Channel with Schluter®-KERDI 1 - HMK-A: 1 AKEY Lift Out Key	50 1/8"	47 7/8"
<input type="checkbox"/> FCSAS 12560	1 - SA 12560 Grate 1 - FC 12560 Fixed Flange Channel with Schluter®-KERDI 1 - HMK-A: 1 AKEY Lift Out Key	62 1/8"	59 7/8"

## Finishes

- Satin Stainless (SS)     Polished Stainless (PS)     Oil Rubbed Bronze (ORB)     Satin Bronze (SB)     Matte Black (BK)

**Infinity Drain**  
145 Dixon Avenue  
Amityville, NY 11701  
Phone: 516.767.6786  
Fax: 516.740.3066  
www.infinitydrain.com

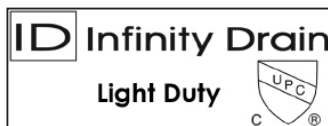

NOTE: Installer must verify all rough-in dimensions prior to installation and consult local and national codes. Conformity and compliance to local and national codes are the responsibility of the installer.

## CUSTOM FLANGE WITH SCHLUTER®-KERDI DRAINS

If you can imagine it, we can manufacture it. Infinity Drain® offers a variety of customized drainage solutions to your exact specification. Customize length, outlets, configuration, styles, and finishes.



### **NEW** Next Day Custom

- Purchase orders and sign offs received by 10am ET will ship the following day
- Completed custom form must accompany purchase order
- Straight configuration and custom lengths up to 96"
- Grate Styles: Wedge Wire, Offset Slotted, Tile Insert Frame
- Installation types: Fixed Flange (FF), Flanged with Schluter® - Kerdi (FCS), and Double Waterproofing (FCB)
- Custom outlet placement for multiple outlets
- Finishes: Satin Stainless, Polished Stainless, Oil Rubbed Bronze, Satin Bronze and Matte Black

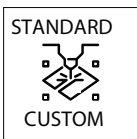
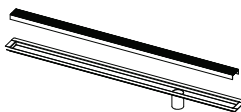

### Standard Custom

- Purchase orders and sign offs received by 10am ET will ship within 15 business days
- Completed custom form must accompany purchase order
- Straight configuration and custom lengths up to 96"
- Any standard grate style options
- Installation types: Fixed Flange (FF), Flanged with Schluter® - Kerdi (FCS), and Double Waterproofing (FCB)
- Custom outlet placement for multiple outlets
- Finishes: Satin Stainless, Polished Stainless, Oil Rubbed Bronze, Satin Bronze and Matte Black

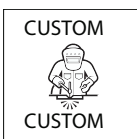
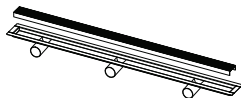

### Custom-Custom

- Specialty installation options (Sink drain, Elevator drain, Threshold drain, Vinyl Clamp drain, etc.)
- Any shape and configuration
- Any installation type
- Any outlet type
- Any finish. Standard finishes and color match finish options available.

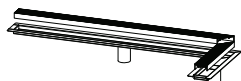

**[CLICK HERE - TO LEARN MORE ABOUT CUSTOM FABRICATION](#)**

For additional information regarding Custom Fabrication, Please contact Technical Support at [info@infinitydrain.com](mailto:info@infinitydrain.com)