



ELVAS 300 Elevator Series Drains

- ELVAS 30036 - 36" Complete Kit
- ELVAS 30042 - 42" Complete Kit
- ELVAS 30048 - 48" Complete Kit

Features

- | | |
|---|--|
| <ul style="list-style-type: none"> ▪ Hemmed channel with centered outlet location ▪ 12 gauge, 316L stainless steel grate ▪ 16 gauge, 304L stainless steel channel ▪ 4" No Hub Outlet ▪ Rated for 100 gallons per minute ▪ Grate can be removed for cleaning | <ul style="list-style-type: none"> ▪ Optional Tamper-Resistant screws ▪ Optional anchor straps |
|---|--|

Installation



Care & Maintenance

ELVAS 300 stainless steel linear drain top grates are made of 316L stainless steel. This material is non-porous, hygienic, rust-free and extremely durable. Bar Keepers Friend® and Soft Scrub® are commonly available products that can be used to protect and clean your Satin Stainless drain cover. For stains that have been left for an excessive amount of time, stronger cleaning agents such as Steel Brite® may be needed. For all finishes we recommend using mild soap and a soft cloth for cleaning. DO NOT use any abrasive cleaners, scrub pads or allow household cleaning agents, such as bleach, to sit on the drain cover for a long period of time. Stainless steel does not rust. External factors, such as contamination from other highly ferrous metals, built up road salt, sea salt, or chlorine may have caused "surface" rust which can be removed using Barkeepers Friend®, Soft Scrub®, or Steel Brite Cleaner. Always follow the directions on the bottle. Follow proper maintenance procedures to prevent excessive surface rust. In areas of frequent exposure to salt, chlorine, and other chemical compounds, maintenance of the stainless grates should be performed at least 2-3 times per year.

Infinity Drain
145 Dixon Avenue
Amityville, NY 11701
Phone: 516.767.6786
Fax: 516.740.3066

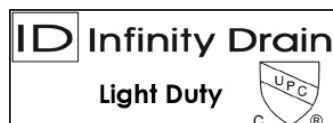

NOTE: Installer must verify all rough-in dimensions prior to installation and consult local and national codes. Conformity and compliance to local and national codes are the responsibility of the installer.

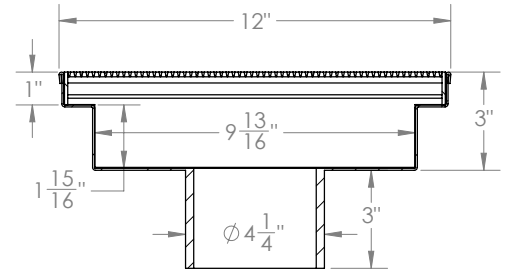
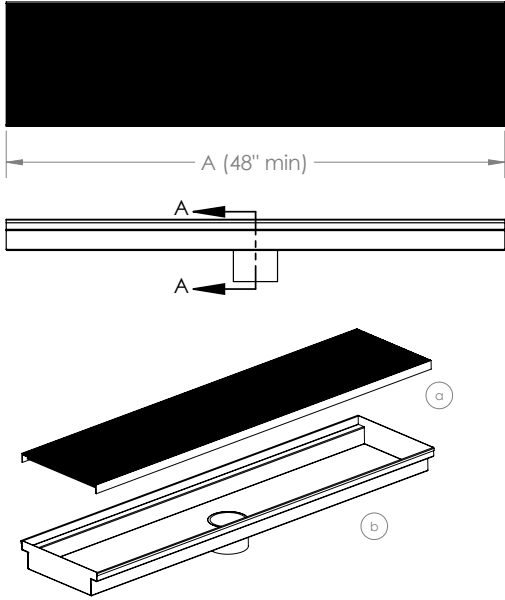

SECTION A-A

- (a) SA 300 - Stainless Steel Grate
- (b) ELV 300 - Stainless Steel Channel

Model Number	Complete Kit Contents		A (Maximum Overall Length)	B (Maximum Grate Length)
<input type="checkbox"/> ELVAS 30036	1 - SA 30036 Grate 1 - XC 30024 Fixed Flange Channel	1 - HMK-A: 1 AKEY Lift Out Key	36"	35 7/8"
<input type="checkbox"/> ELVAS 30042	1 - SA 30042 Grate 1 - XC 30032 Fixed Flange Channel	1 - HMK-A: 1 AKEY Lift Out Key	42"	41 7/8"
<input type="checkbox"/> ELVAS 30048	1 - SA 30048 Grate 1 - XC 30036 Fixed Flange Channel	1 - HMK-A: 1 AKEY Lift Out Key	48"	47 7/8"

Finishes

Satin Stainless (SS)

Polished Stainless (PS)

Infinity Drain
145 Dixon Avenue
Amityville, NY 11701
Phone: 516.767.6786
Fax: 516.740.3066

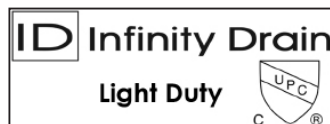

NOTE: Installer must verify all rough-in dimensions prior to installation and consult local and national codes. Conformity and compliance to local and national codes are the responsibility of the installer.

CUSTOM FABRICATION SOLUTIONS

If you can imagine it, we can manufacture it. Infinity Drain® offers a variety of customized drainage solutions to your exact specification. Customize length, outlets, configuration, styles, and finishes.



NEW Next Day Custom

- Purchase orders and sign offs received by 10am ET will ship the following day
- Completed custom form must accompany purchase order
- Straight configuration and custom lengths up to 96"
- Grate Styles: Wedge Wire, Offset Slotted, Tile Insert Frame
- Installation types: Fixed Flange (FF), Flanged with Schluter® - Kerdi (FCS), and Double Waterproofing (FCB)
- Custom outlet placement for multiple outlets
- Finishes: Satin Stainless, Polished Stainless, Oil Rubbed Bronze, Satin Bronze and Matte Black

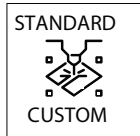
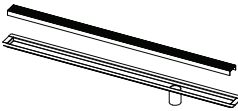

Standard Custom

- Purchase orders and sign offs received by 10am ET will ship within 15 business days
- Completed custom form must accompany purchase order
- Straight configuration and custom lengths up to 96"
- Any standard grate style options
- Installation types: Fixed Flange (FF), Flanged with Schluter® - Kerdi (FCS), and Double Waterproofing (FCB)
- Custom outlet placement for multiple outlets
- Finishes: Satin Stainless, Polished Stainless, Oil Rubbed Bronze, Satin Bronze and Matte Black

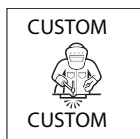
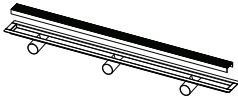

Custom-Custom

- Specialty installation options (Sink drain, Elevator drain, Threshold drain, Vinyl Clamp drain, etc.)
- Any shape and configuration
- Any installation type
- Any outlet type
- Any finish. Standard finishes and color match finish options available.

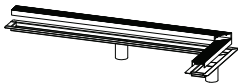

[CLICK HERE - TO LEARN MORE ABOUT CUSTOM FABRICATION](#)

For additional information regarding Custom Fabrication, Please contact Technical Support at info@infinitydrain.com