

XC 125 Specifications

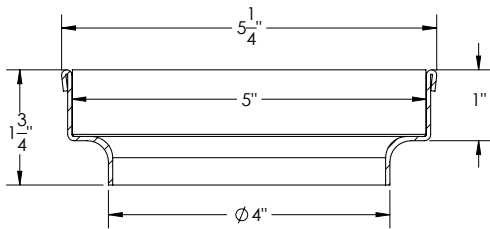

XC 125:

- Fixed Length Stainless Steel channel for the following models:
FXAS 125 series drain
- Fixed Length NOT Site Sizable™
- 4" threaded waste line connection via TN4A threaded outlet
(included with channel)

Models (overall dimensions):

- XC 12532: 32" L x 5 1/4" W x 4" H
- XC 12536: 36" L x 5 1/4" W x 4" H
- XC 12542: 42" L x 5 1/4" W x 4" H
- XC 12548: 48" L x 5 1/4" W x 4" H
- XC 12560: 60" L x 5 1/4" W x 4" H

Finishes:

- Satin Stainless - SS
- Polished Stainless - PS
- Satin Bronze - SB
- Oil Rubbed Bronze - ORB
- Matte Black - BK

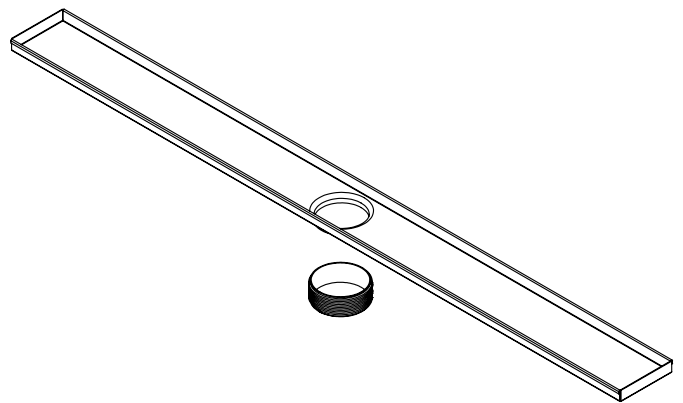
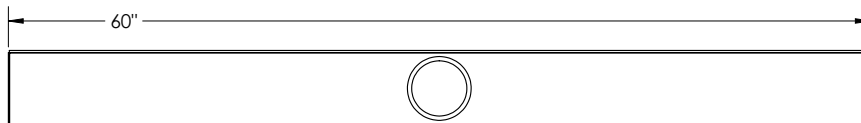
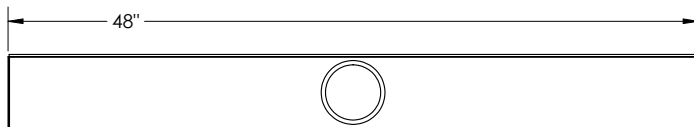
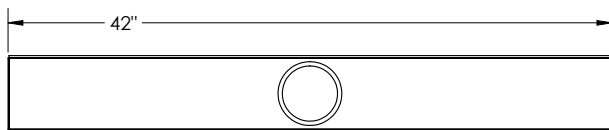
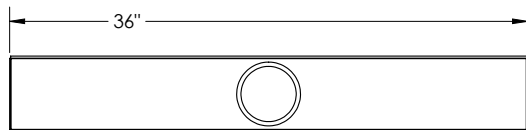
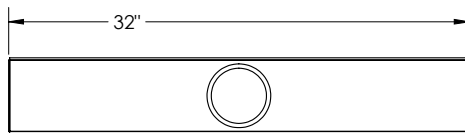

Infinity Drain
145 Dixon Avenue
Amityville, NY 11701
Phone: 516.767.6786
Fax: 516.740.3066
www.infinitydrain.com



NOTE: Installer must verify all rough-in dimensions prior to installation and consult local and national codes. Conformity and compliance to local and national codes are the responsibility of the installer.