

ID Infinity Drain

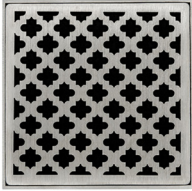

MD 4-2 Moor Premium Center Drain Series

Complete Kits:

- MD 4-2I
- MD 4-2P
- MD 4-2A

Features

- 304L Stainless Steel Throat and Decorative Plate
- 3/16" Thick decorative plate
- 3/8" Depth throat
- Interior or Exterior use
- Grate can be removed completely for cleaning
- Requires traditional 4-way floor pitch
- Flow rate 9 GPM with 2" outlet

Installation

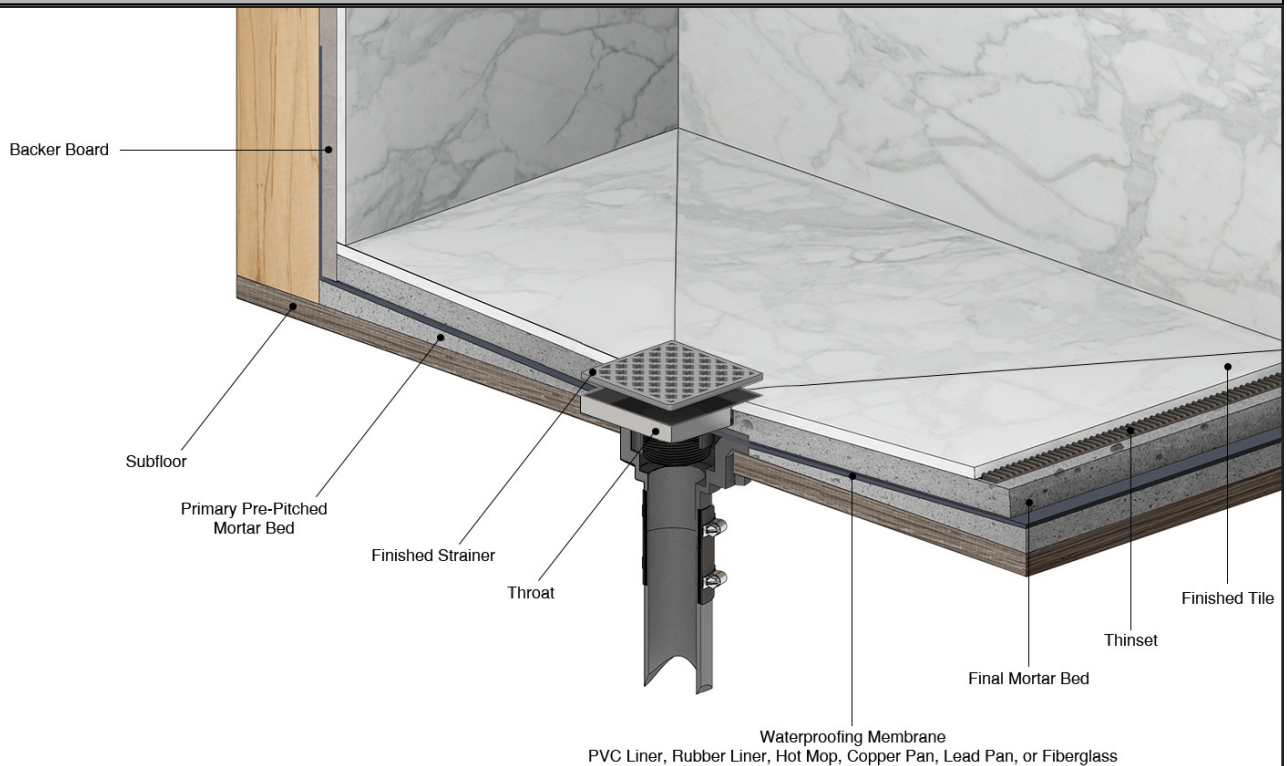

Care & Maintenance

MD 4-2 stainless steel throat and decorative plate are made of 304L stainless steel. This material is non-porous, hygienic, rust-free and extremely durable. Bar Keepers Friend® and Soft Scrub® are commonly available products that can be used to protect and clean your Satin Stainless drain cover. For stains that have been left for an excessive amount of time, stronger cleaning agents such as Steel Brite® may be needed. For all finishes we recommend using mild soap and a soft cloth for cleaning. DO NOT use any abrasive cleaners, scrub pads or allow household cleaning agents, such as bleach, to sit on the drain cover for a long period of time. Stainless steel does not rust. External factors, such as contamination from other highly ferrous metals, built up road salt, sea salt, or chlorine may have caused "surface" rust which can be removed using Barkeepers Friend®, Soft Scrub®, or Steel Brite Cleaner. Always follow the directions on the bottle. Follow proper maintenance procedures to prevent excessive surface rust. In areas of frequent exposure to salt, chlorine, and other chemical compounds, maintenance of the stainless grates should be performed at least 2-3 times per year.

Infinity Drain
145 Dixon Avenue
Amityville, NY 11701
Phone: 516.767.6786
Fax: 516.740.3066
www.InfinityDrain.com



NOTE: Installer must verify all rough-in dimensions prior to installation and consult local and national codes. Conformity and compliance to local and national codes are the responsibility of the installer.

MD 4-2 Specifications

ID Infinity Drain

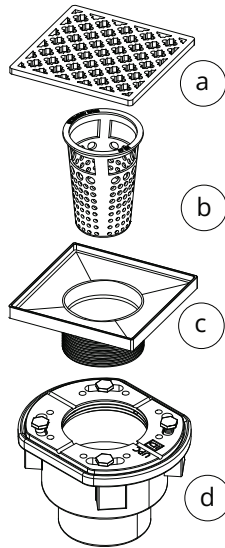

- (a) MS 4 - Decorative Plate
- (b) HB 65 - Hair Basket
- (c) T 42 - 2" Throat
- (d) 2 inch Drain Body

Finishes Available:

- Satin Stainless (SS)
- Polished Stainless (PS)
- Oil Rubbed Bronze (ORB)
- Satin Bronze (SB)
- Matte Black (BK)
- Satin Champagne (SC)
- Polished Gold (PG)
- Polished Brass (PB)
- Gunmetal (GM)
- Matte White (MW)

Components:

MD 4-2I

4" x 4" Kit with Cast Iron Drain Body
2" Throat. 2" No Hub Outlet.

Kit Includes:

- (4" L x 4" W x 3/8" H) - Strainer
- 1 - MS 4 Moor Decorative Plate
- 1 - T 42 Throat
- 1 - HMK-C2-D Hair Maintenance Kit:
 - 1 - HB 65 Hair Basket
 - 1 - DKEY Lift Out Key
- 1 - CDI 22 Cast Iron Drain Body Assembly

MD 4-2A

4" x 4" Kit with ABS Drain Body
2" Throat. 2" No Hub Outlet.

Kit Includes:

- (4" L x 4" W x 3/8" H)- Strainer
- 1 - MS 4 Moor Decorative Plate
- 1 - T 42 Throat
- 1 - HMK-C2-D Hair Maintenance Kit:
 - 1 - HB 65 Hair Basket
 - 1 - DKEY Lift Out Key
- 1 - CDA 22 ABS Assembly

MD 4-2P

4" x 4" Kit with PVC Drain Body
2" Throat. 2" No Hub Outlet.

Kit Includes:

- (4" L x 4" W x 3/8" H)- Strainer
- 1 - MS 4 Moor Decorative Plate
- 1 - T 42 Throat
- 1 - HMK-C2-D Hair Maintenance Kit:
 - 1 - HB 65 Hair Basket
 - 1 - DKEY Lift Out Key
- 1 - CDP 22 PVC Assembly

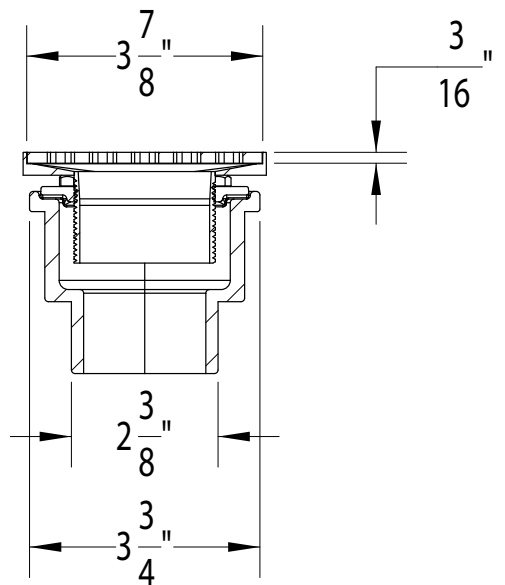
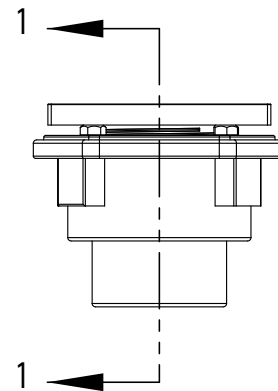
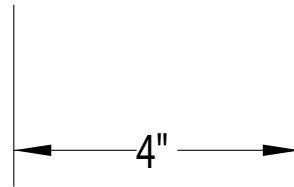
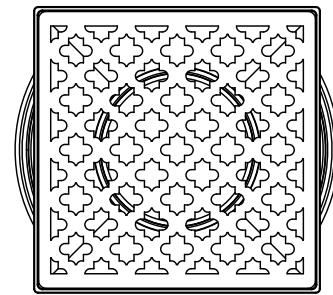

SECTION 1-1

Infinity Drain
145 Dixon Avenue
Amityville, NY 11701
Phone: 516.767.6786
Fax: 516.740.3066
www.InfinityDrain.com



NOTE: Installer must verify all rough-in dimensions prior to installation and consult local and national codes. Conformity and compliance to local and national codes are the responsibility of the installer.