

# FTED 25 Series

## FTED 25 | Fixed Length

- 16 gauge 304 Stainless Steel grate and channel
- Pre-pitched channel with "Fixed" lengths and "Fixed" center side "tunnel" outlet location
- Not site sizeable
- Indoor or outdoor use
- Bonded "Flange" installation for flush against the wall
- Allows waste line to connect horizontally to save floor height and waste line relocation
- Lowest height for curbless installations
- Uses Liquid and Fabric Sheet Membrane waterproofing
- Grate can be removed completely for cleaning
- Flow rate 9 GPM per outlet\*

\*Flow rate measured at outlet only. Measurement does not account for water in channel or sheeting on shower floor.

### Finishes:

- \_\_\_ Satin Stainless
- \_\_\_ Polished Stainless



## Installation (FT) Flange Tunnel

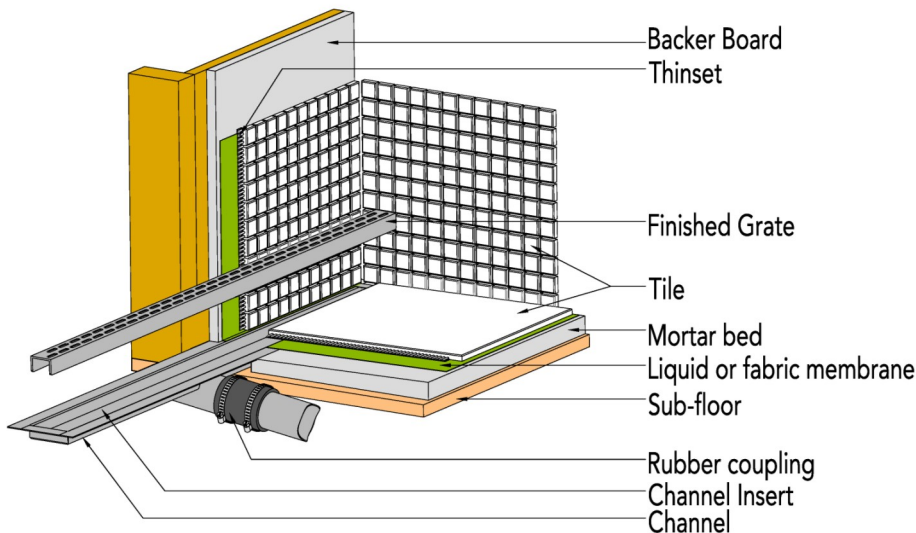

### Complete Kits:

FTED 2532	32" Complete Kit
FTED 2536	36" Complete Kit
FTED 2542	42" Complete Kit
FTED 2548	48" Complete Kit
FTED 2560	60" Complete Kit

### Components:

EA 2532	32" Stainless Steel Grate
EA 2536	36" Stainless Steel Grate
EA 2542	42" Stainless Steel Grate
EA 2548	48" Stainless Steel Grate
EA 2560	60" Stainless Steel Grate
OC 6532	32" Fixed Flange Channel
OC 6536	36" Fixed Flange Channel
OC 6542	42" Fixed Flange Channel
OC 6548	48" Fixed Flange Channel
OC 6560	60" Fixed Flange Channel
CI 2532	32" Channel Insert
CI 2536	36" Channel Insert
CI 2542	42" Channel Insert
CI 2548	48" Channel Insert
CI 2560	60" Channel Insert

### Infinity Drain

18 Secatoag Avenue  
 Port Washington, NY 11050  
 Phone: 516.767.6786  
 Fax: 516.740.3066  
 www.InfinityDrain.com

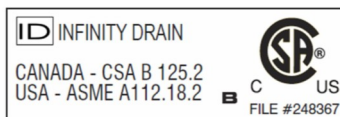

**Note:** Installer must verify all rough-in dimensions prior to installation and consult local and national codes. Conformity and compliance to local and national codes are the responsibility of the installer.

# FTED 2536 Specifications

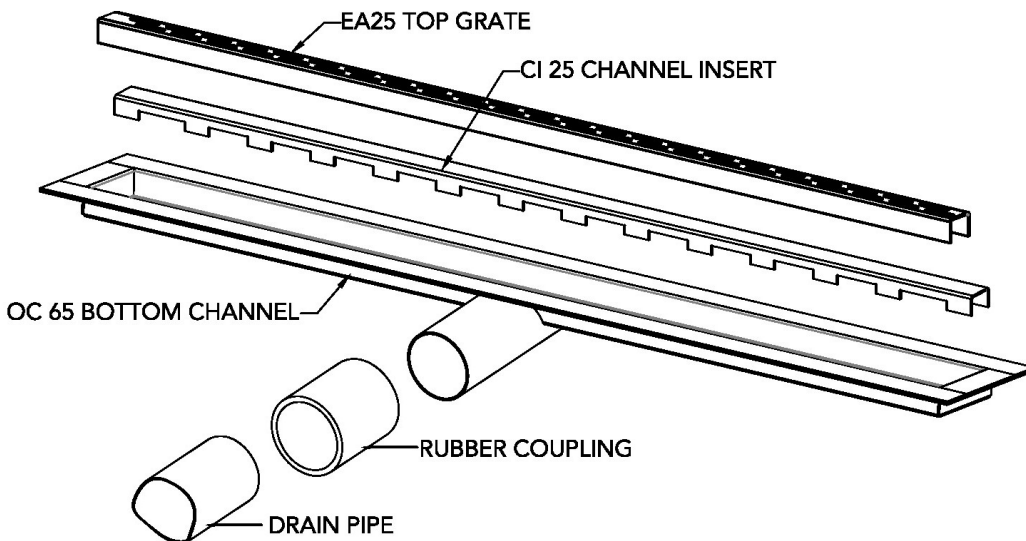
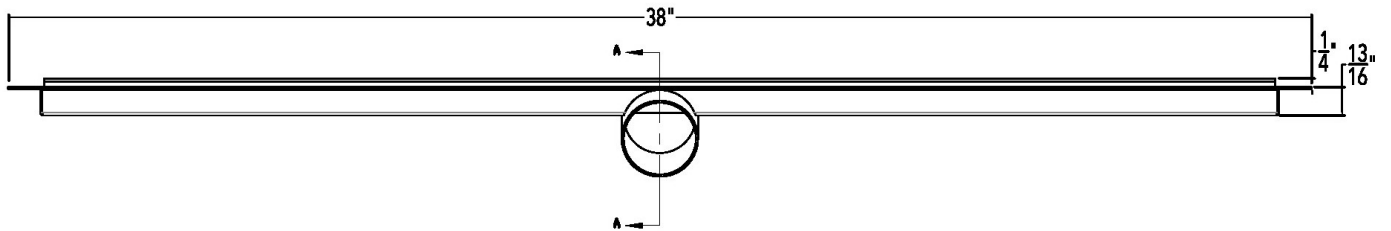
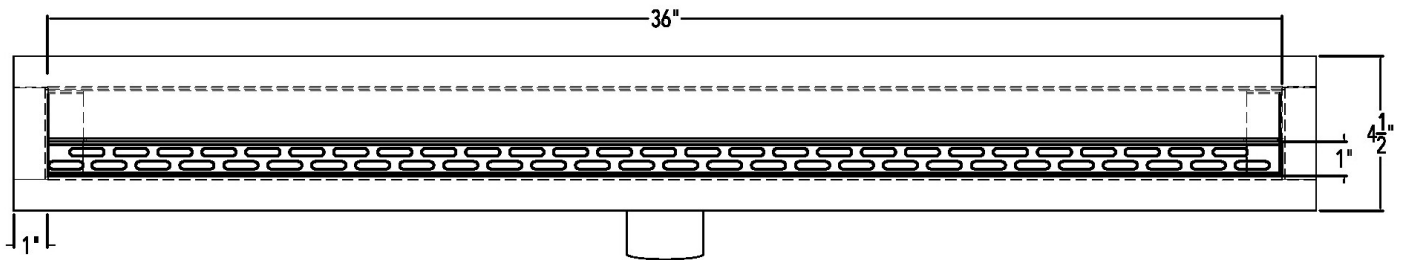

DRAIN CAN BE ADJUSTED UPWARD FOR AN ADDITIONAL 1/2" IN HEIGHT

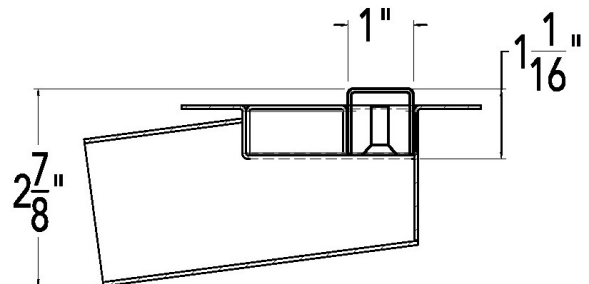

SECTION A-A

## FTED 2536

### 36" Complete Kit Includes:

(38 1/8" l x 4 1/2" w x 1 3/16" h)

- 1 - EA 2536 Grate
- 1 - OC 6536 Fixed Flange Channel
- 1 - CI 2536 Channel Insert

## Infinity Drain

18 Secatoag Avenue  
 Port Washington, NY 11050  
 Phone: 516.767.6786  
 Fax: 516.740.3066  
 www.InfinityDrain.com

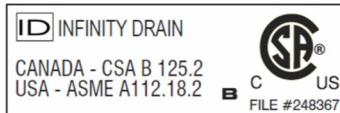

**Note:** Installer must verify all rough-in dimensions prior to installation and consult local and national codes. Conformity and compliance to local and national codes are the responsibility of the installer.