

CDA 43 Specifications

CDA 43:

- ABS Clamp Down Drain
- 4" Throat
- 3" Outlet
- 8" overall diameter

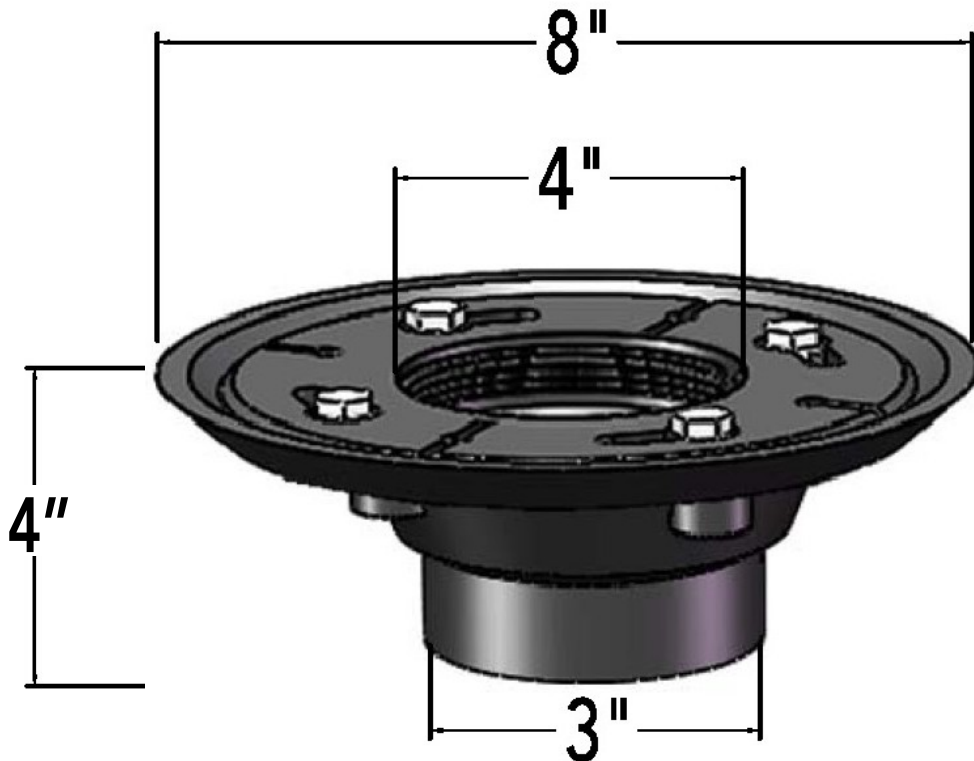

Infinity Drain

18 Secatoag Avenue
Port Washington, NY 11050
Phone: 516.767.6786
Fax: 516.740.3066
www.InfinityDrain.com

Note: Installer must verify all rough-in dimensions prior to installation and consult local and national codes. Conformity and compliance to local and national codes are the responsibility of the installer.