

S-TIFAS 65 Series

S-TIFAS 65 | Site Sizeable

- Modify length and locate outlet on-site
- Indoor or outdoor use
- Incorporates tile or solid surface material up to 3/4" thick within the grate frame
- 316 stainless steel grate
- Stainless steel channel
- Works with 2" clamp down floor drain with 2" throat (strainer size)
- Uses Hot Mop, Lead Pan, PVC Vinyl Liner, Rubber Liner (Chloraloy™) Copper Pan or Fiberglass waterproofing
- Grate can be removed completely for cleaning
- Flow rate 9 GPM per outlet*

Finishes:

- Satin Stainless
- Polished Stainless



Installation (S) Site Sizable

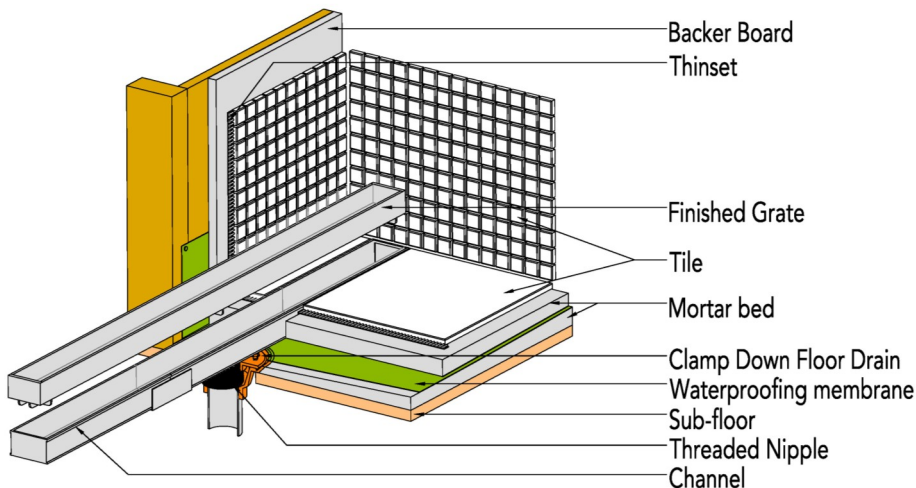

Complete Kits:

S-TIFAS 6540	40" Complete Kit
S-TIFAS 6548	48" Complete Kit
S-TIFAS 6560	60" Complete Kit
S-TIFAS 6580	80" Complete Kit
S-TIFAS 6596	96" Complete Kit

Longer lengths for indoor or outdoor installations.

Components:

TA 6540	40" Stainless Steel Grate
TA 6548	48" Stainless Steel Grate
TA 6560	60" Stainless Steel Grate
TC 6548	48" Stainless Open Ended Channel
TC 6596	96" Stainless Open Ended Channel
HC 6532	32" Stainless Closed Ended Channel
HC 6540	40" Stainless Closed Ended Channel
HC 6552	52" Stainless Closed Ended Channel
HC 6572	72" Stainless Closed Ended Channel
HC 6588	88" Stainless Closed Ended Channel
HF 65	8" Stainless Steel Outlet Section
TJS 65	Stainless Steel Joiner Strip
TNAS	Stainless Steel Threaded
TIF PL	Nipple TIF Plates
TKEY	Lift Out Key
Sikaflex	1a Construction Sealant

Add Clamp Down Drain:

CDI 22	Clamp Down Drain Cast Iron
CDA 22	Clamp Down Drain ABS
CDP 22	Clamp Down Drain PVC

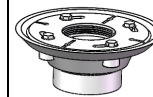

2" clamp down drain not included in kit

Optional Components:

SHA 65	Stainless Steel 90° Angle Joiner
TNRN	Stainless Steel Threaded Nipple, (3" extension)
UCP 2	Universal 2" Clamping Plate
UCP 4	Universal 4" Clamping Plate
ERB	Eccentric Reducer Bushing 4" x 2"
TE 65	Stainless Steel End Section

Note: Installer must verify all rough-in dimensions prior to installation and consult local and national codes. Conformity and compliance to local and national codes are the responsibility of the installer.

Infinity Drain

18 Secatoag Avenue
Port Washington, NY 11050
Phone: 516.767.6786
Fax: 516.740.3066
www.InfinityDrain.com

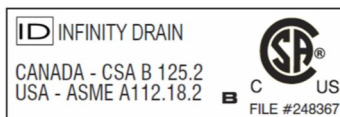

S-TIFAS 6596 Specifications

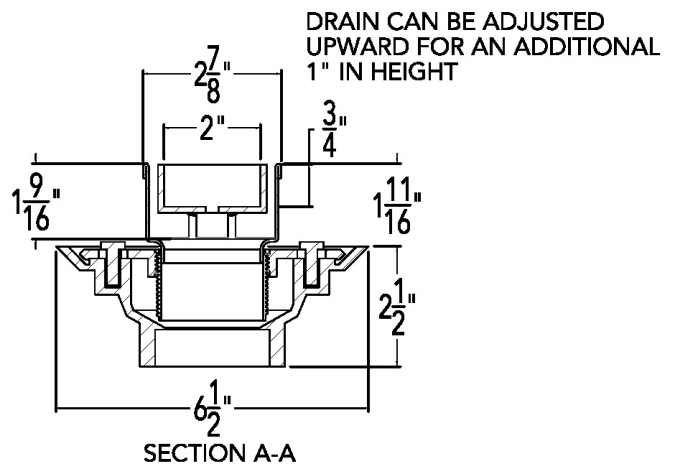
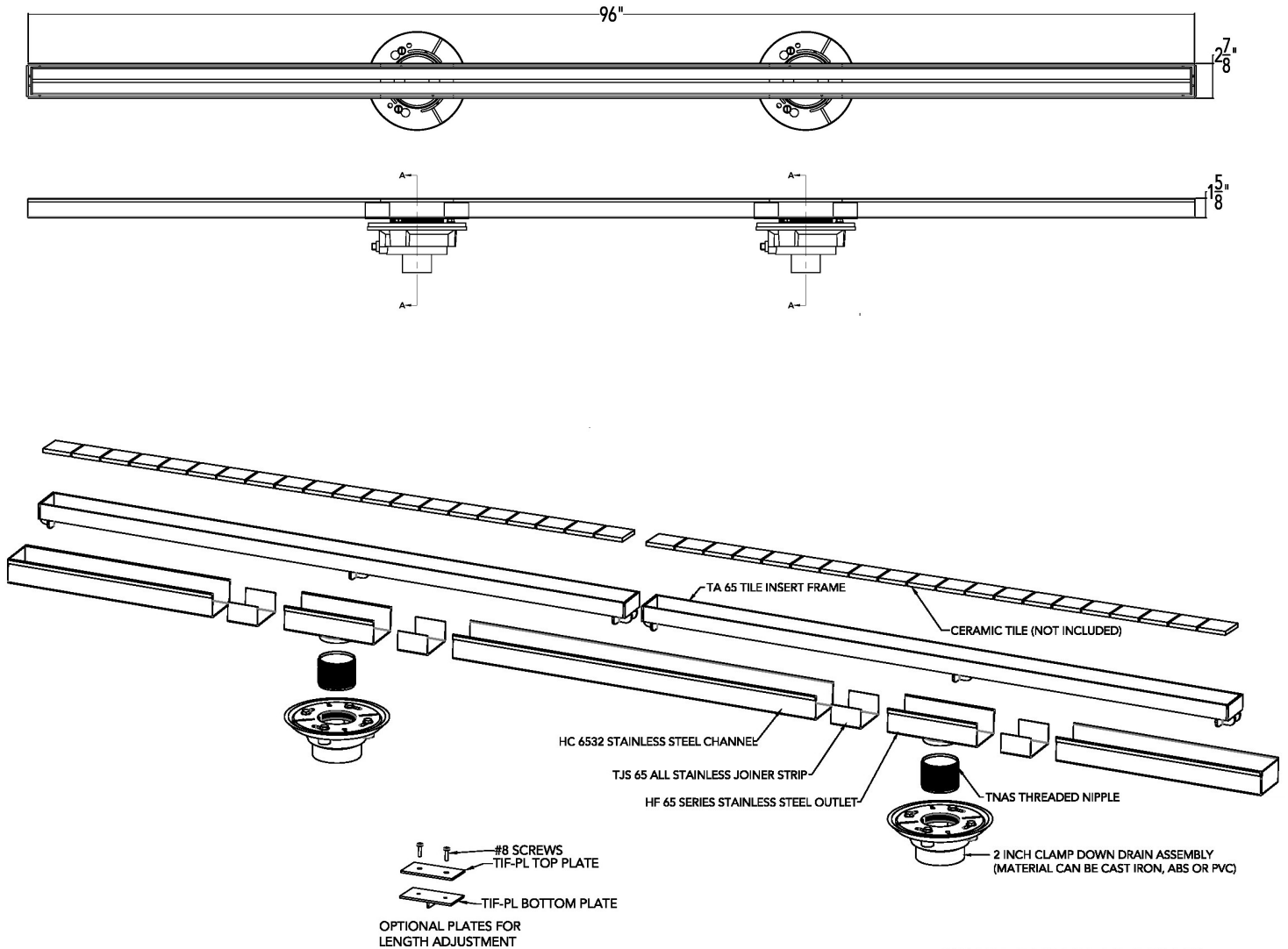

S-TIFAS 6596 SS

96" Complete Kit Includes:

- (96 1/8" l x 2 7/8" w x 1 5/8" h)
- 2 - TA 6548 Tile Insert Frame
- 1 - HC 6588 Stainless Steel Channel
- 2 - HF 65 8" Outlet Section Stainless Steel
- 4 - TJS 65 Stainless Steel Joiner Strip
- 2 - TNAS Threaded Nipple
- 1 - TKEY Lift Out Key
- 1 - Sikaflex 1a Construction Sealant

Infinity Drain

18 Secatoag Avenue
 Port Washington, NY 11050
 Phone: 516.767.6786
 Fax: 516.740.3066
 www.InfinityDrain.com

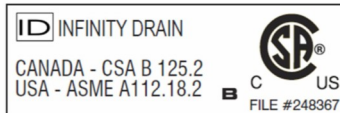

Note: Installer must verify all rough-in dimensions prior to installation and consult local and national codes. Conformity and compliance to local and national codes are the responsibility of the installer.