

FXMN 65 Series



FXMN 65 | Fixed Length

- 14 gauge 304 Stainless Steel grate and channel
- Pre-pitched channel with "Fixed" lengths and "Fixed" center outlet
- Not site sizeable
- Indoor or outdoor use
- Works with 2" clamp down floor drain with 2" throat (strainer size) (not included)
- Uses Hot Mop, Lead Pan, PVC Vinyl Liner, Rubber Liner (Chloraloy™) Copper Pan or Fiberglass waterproofing
- Grate can be removed completely for cleaning
- Flow rate 9 GPM per outlet*

*Flow rate measured at outlet only. Measurement does not account for water in channel or sheeting on shower floor.

Finishes:

- ___ Satin Stainless
- ___ Polished Stainless
- ___ Lifetime Oil
- ___ Rubbed Bronze
- ___ Matte White
- ___ Matte Black

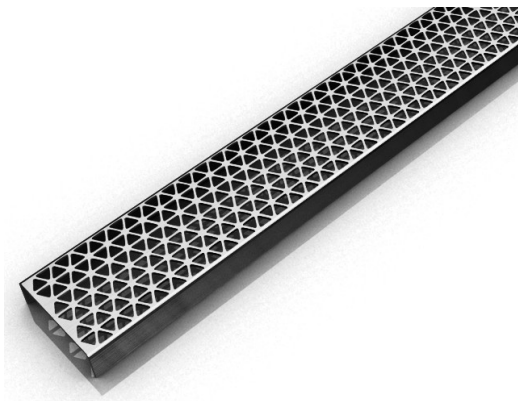

Installation (FX) Fixed

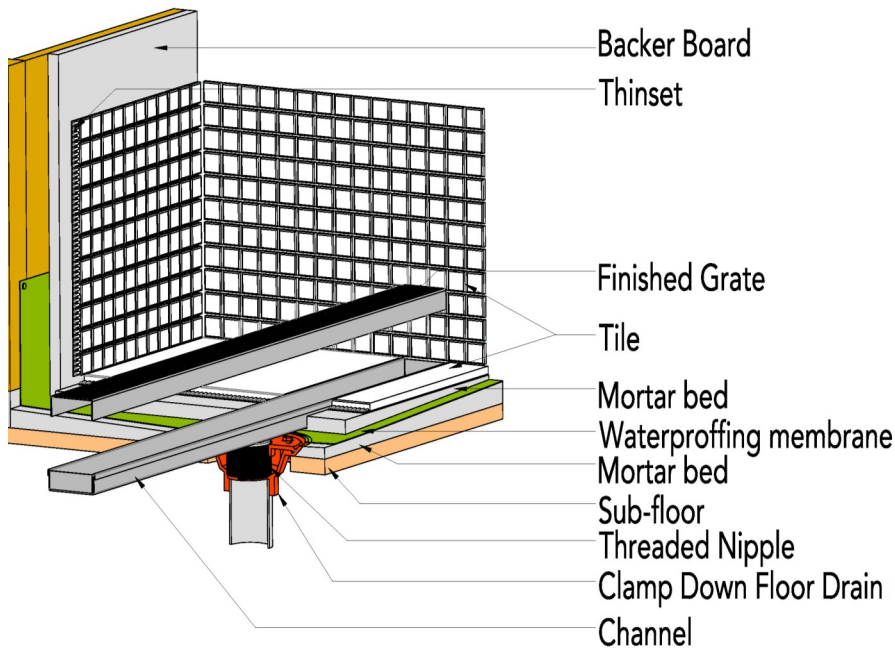

Complete Kits:

- FXMN 6532 32" Complete Kit
- FXMN 6536 36" Complete Kit
- FXMN 6542 42" Complete Kit
- FXMN 6548 48" Complete Kit
- FXMN 6560 60" Complete Kit

Components:

- MA 6532 32" Stainless Steel Grate
- MA 6536 36" Stainless Steel Grate
- MA 6542 42" Stainless Steel Grate
- MA 6548 48" Stainless Steel Grate
- MA 6560 60" Stainless Steel Grate
- XC 6532 32" Stainless Steel Fixed Channel
- XC 6536 36" Stainless Steel Fixed Channel
- XC 6542 42" Stainless Steel Fixed Channel
- XC 6548 48" Stainless Steel Fixed Channel
- XC 6560 60" Stainless Steel Fixed Channel
- TNAS Stainless Steel Threaded Nipple

Add Clamp Down Drain:

- CDA 22 Clamp Down Drain ABS
- CDI 22 Clamp Down Drain Cast Iron
- CDP 22 Clamp Down Drain PVC

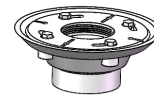

2" clamp down drain not included in kit

Optional Components:

- TNRN Stainless Steel Threaded Nipple (3" extension)
- UCP 2 Universal 2" Clamping Plate
- UCP 4 Universal 4" Clamping Plate
- ERB Eccentric Reducer Bushing 4"x2"

Note: Installer must verify all rough-in dimensions prior to installation and consult local and national codes. Conformity and compliance to local and national codes are the responsibility of the installer.

Infinity Drain

18 Secatoag Avenue
Port Washington, NY 11050
Phone: 516.767.6786
Fax: 516.740.3066
www.InfinityDrain.com

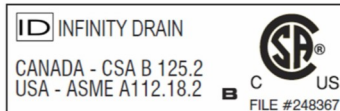

FXMN 6560 Specifications

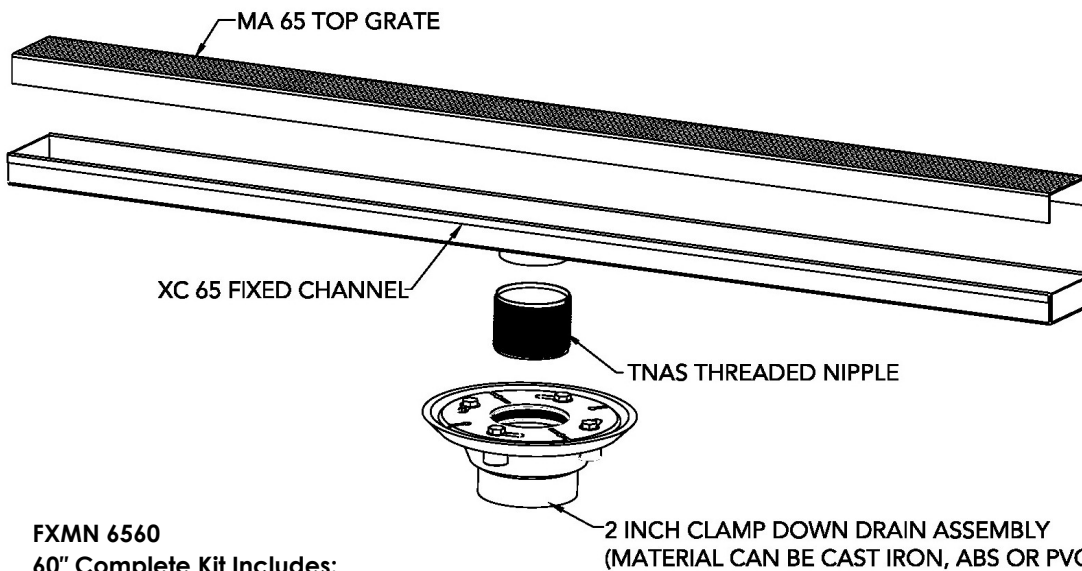
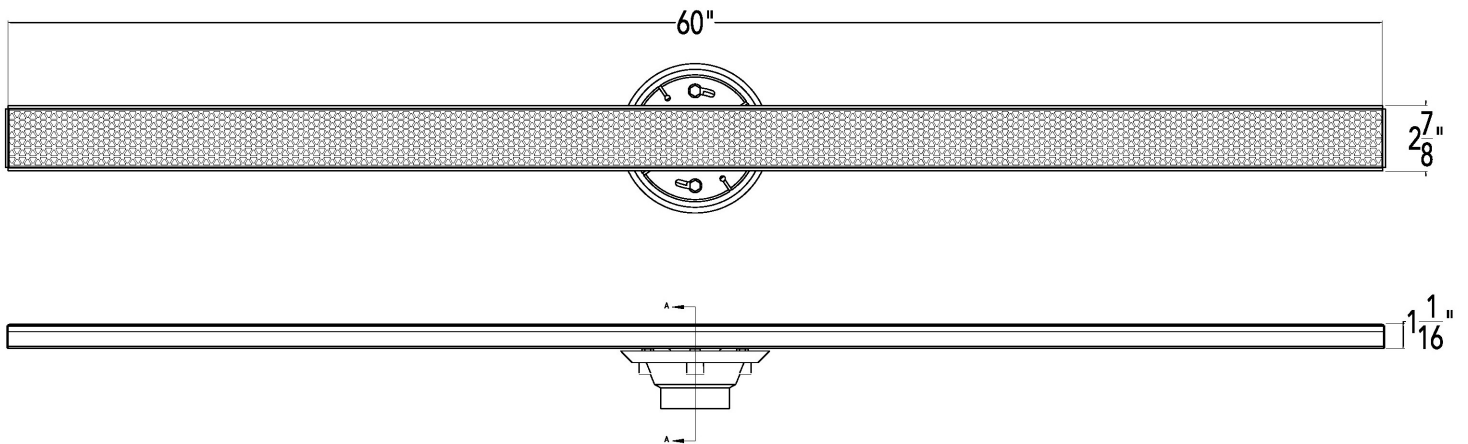

FXMN 6560

60" Complete Kit Includes:

(60 1/8" l x 2 7/8" w x 1" h)

- 1 - MA 6548 Stainless Steel Grate
- 1 - XC 6548 Fixed Channel
- 1 - TNAS Threaded Nipple

Add Clamp Down Drain:

- CDA 22 Clamp Down Drain ABS
- CDI 22 Clamp Down Drain Cast Iron
- CDP 22 Clamp Down Drain PVC

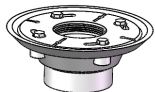

2" clamp down drain not included in kit

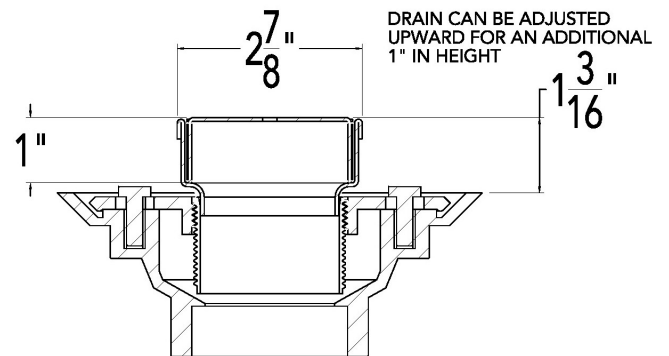

SECTION A-A

Note: Installer must verify all rough-in dimensions prior to installation and consult local and national codes. Conformity and compliance to local and national codes are the responsibility of the installer.

Infinity Drain

18 Secatoag Avenue
 Port Washington, NY 11050
 Phone: 516.767.6786
 Fax: 516.740.3066
 www.InfinityDrain.com

