

FXDG 65 Series



FXDG 65 | Fixed Length

- 16 gauge 304 Stainless Steel grate and channel
- Pre-pitched channel with "Fixed" lengths and "Fixed" center outlet
- Not site sizeable
- Indoor or outdoor use
- Works with 2" clamp down floor drain with 2" throat (strainer size) (not included)
- Uses Hot Mop, Lead Pan, PVC Vinyl Liner, Rubber Liner (Chloraloy™) Copper Pan or Fiberglass waterproofing
- Grate can be removed completely for cleaning
- Flow rate 9 GPM per outlet*

*Flow rate measured at outlet only. Measurement does not account for water in channel or sheeting on shower floor.

Finishes:

- ___ Satin Stainless
- ___ Polished Stainless

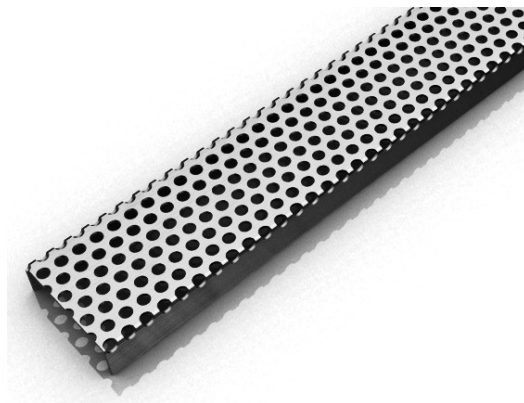

Installation (FX) Fixed

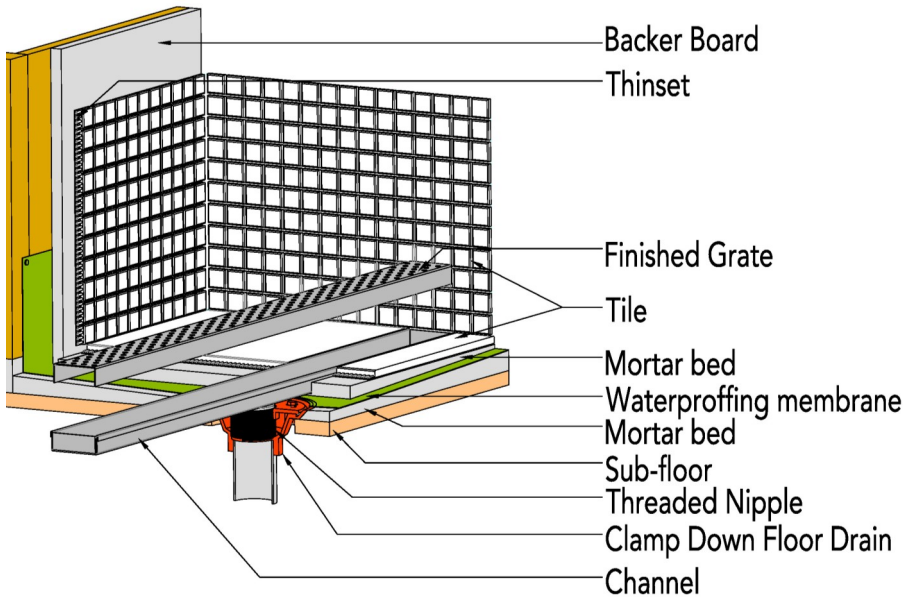

Complete Kits:

- FXDG 6532 32" Complete Kit
- FXDG 6536 36" Complete Kit
- FXDG 6542 42" Complete Kit
- FXDG 6548 48" Complete Kit
- FXDG 6560 60" Complete Kit

Components:

- DA 6532 32" Stainless Steel Grate
- DA 6536 36" Stainless Steel Grate
- DA 6542 42" Stainless Steel Grate
- DA 6548 48" Stainless Steel Grate
- DA 6560 60" Stainless Steel Grate
- XC 6532 32" Stainless Steel Fixed Channel
- XC 6536 36" Stainless Steel Fixed Channel
- XC 6542 42" Stainless Steel Fixed Channel
- XC 6548 48" Stainless Steel Fixed Channel
- XC 6560 60" Stainless Steel Fixed Channel
- TNAS Stainless Steel Threaded Nipple

Add Clamp Down Drain:

- CDA 22 Clamp Down Drain ABS
- CDI 22 Clamp Down Drain Cast Iron
- CDP 22 Clamp Down Drain PVC

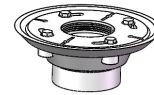

2" clamp down drain not included in kit

Optional Components:

- TNRN Stainless Steel Threaded Nipple (3" extension)
- UCP 2 Universal 2" Clamping Plate
- UCP 4 Universal 4" Clamping Plate
- ERB Eccentric Reducer Bushing 4"x2"

Infinity Drain

18 Secatoag Avenue
 Port Washington, NY 11050
 Phone: 516.767.6786
 Fax: 516.740.3066
 www.InfinityDrain.com

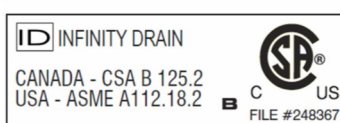

Note: Installer must verify all rough-in dimensions prior to installation and consult local and national codes. Conformity and compliance to local and national codes are the responsibility of the installer.

FXDG 6532 Specifications

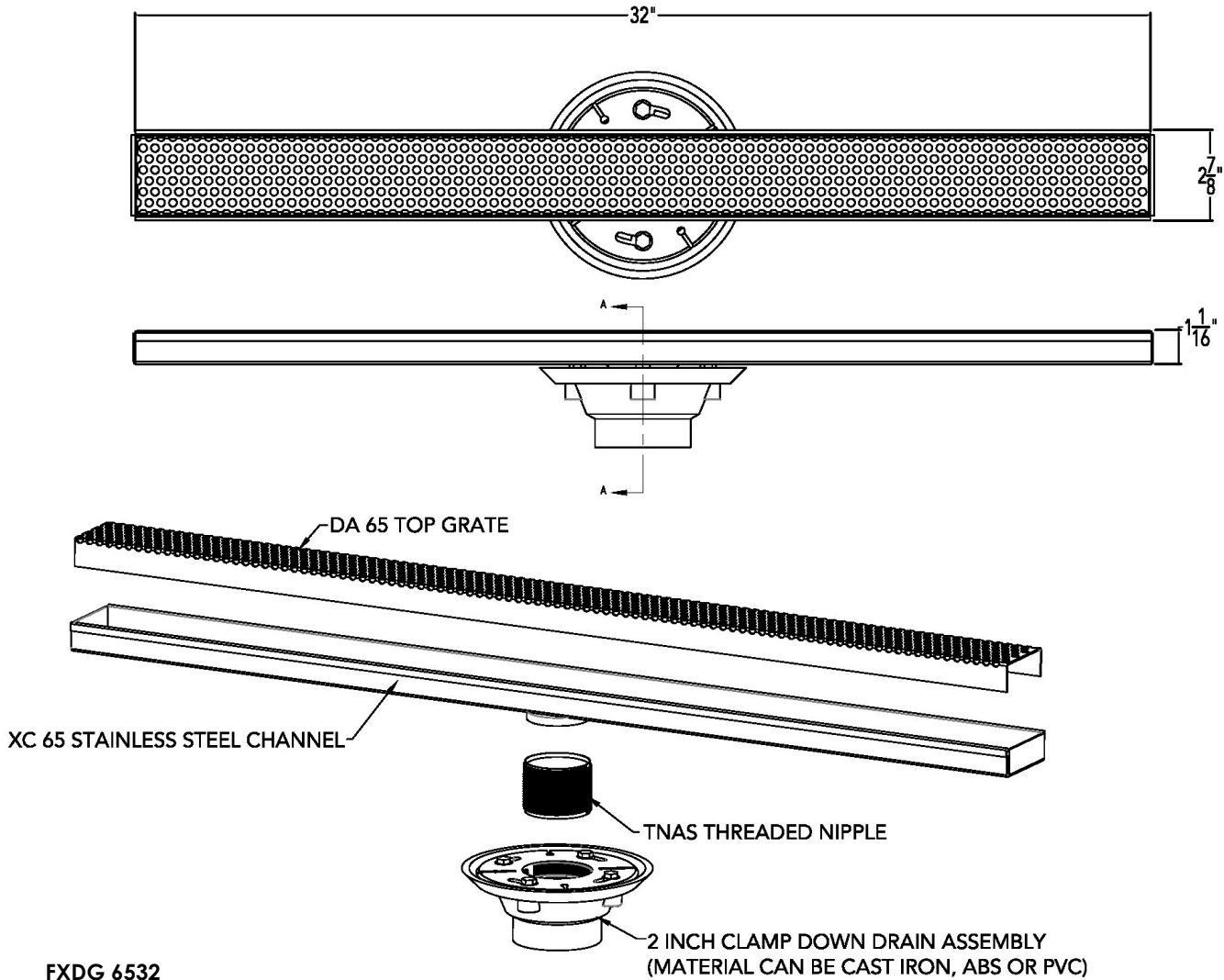

FXDG 6532

32" Complete Kit Includes:

(32 1/8" l x 2 7/8" w x 1" h)

- 1 - DA 6532 Stainless Steel Grate
- 1 - XC 6532 Fixed Channel
- 1 - TNAS Threaded Nipple

Add Clamp Down Drain:

- CDA 22 Clamp Down Drain ABS
- CDI 22 Clamp Down Drain Cast Iron
- CDP 22 Clamp Down Drain PVC

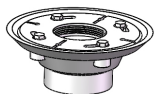

2" clamp down drain not included in kit

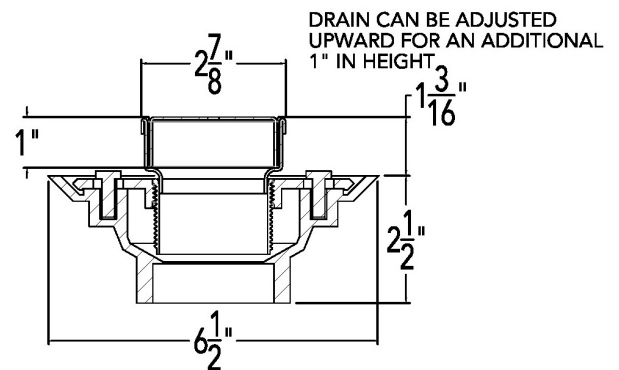

SECTION A-A

Note: Installer must verify all rough-in dimensions prior to installation and consult local and national codes. Conformity and compliance to local and national codes are the responsibility of the installer.

Infinity Drain

18 Secatoag Avenue
 Port Washington, NY 11050
 Phone: 516.767.6786
 Fax: 516.740.3066
 www.InfinityDrain.com

