

FTED 65 Series



FTED 65 | Fixed Length

- 16 gauge 304 Stainless Steel grate and channel
- Pre-pitched channel with "Fixed" lengths and "Fixed" center side "tunnel" outlet location
- Not site sizeable
- Indoor or outdoor use
- Bonded "Flange" installation for flush against the wall
- Allows waste line to connect horizontally to save floor height and waste line relocation
- Lowest height for curbless installations
- Uses Liquid and Fabric Sheet Membrane waterproofing
- Grate can be removed completely for cleaning
- Flow rate 9 GPM per outlet*

*Flow rate measured at outlet only. Measurement does not account for water in channel or sheeting on shower floor.

Finishes:

- ___ Satin Stainless
- ___ Polished Stainless

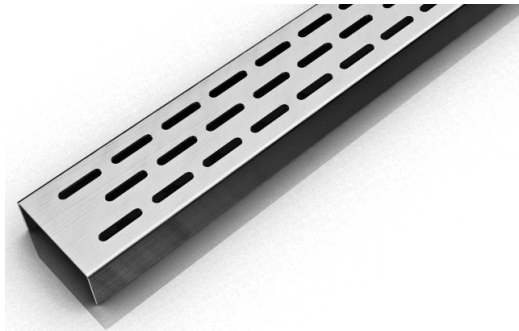

Installation (FT) Flange Tunnel

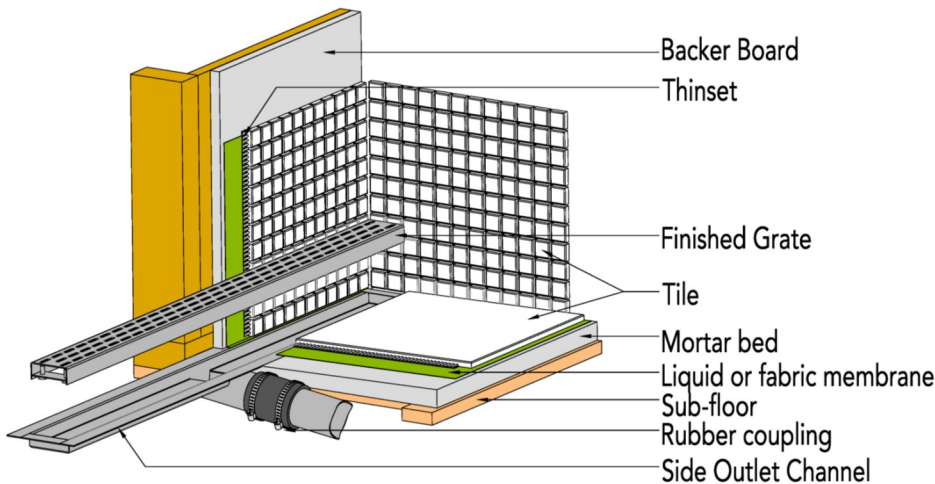

Complete Kits:

FTED 6524	24" Complete Kit
FTED 6532	32" Complete Kit
FTED 6536	36" Complete Kit
FTED 6542	42" Complete Kit
FTED 6548	48" Complete Kit
FTED 6560	60" Complete Kit

Components:

EA 6524	24" Stainless Steel Grate
EA 6532	32" Stainless Steel Grate
EA 6536	36" Stainless Steel Grate
EA 6542	42" Stainless Steel Grate
EA 6548	48" Stainless Steel Grate
EA 6560	60" Stainless Steel Grate
OC 6524	24" Fixed Flange Channel
OC 6532	32" Fixed Flange Channel
OC 6536	36" Fixed Flange Channel
OC 6542	42" Fixed Flange Channel
OC 6548	48" Fixed Flange Channel
OC 6560	60" Fixed Flange Channel

Infinity Drain

18 Secatoag Avenue
 Port Washington, NY 11050
 Phone: 516.767.6786
 Fax: 516.740.3066
 www.InfinityDrain.com

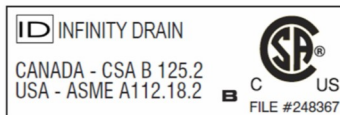

Note: Installer must verify all rough-in dimensions prior to installation and consult local and national codes. Conformity and compliance to local and national codes are the responsibility of the installer.

FTED 6542 Specifications

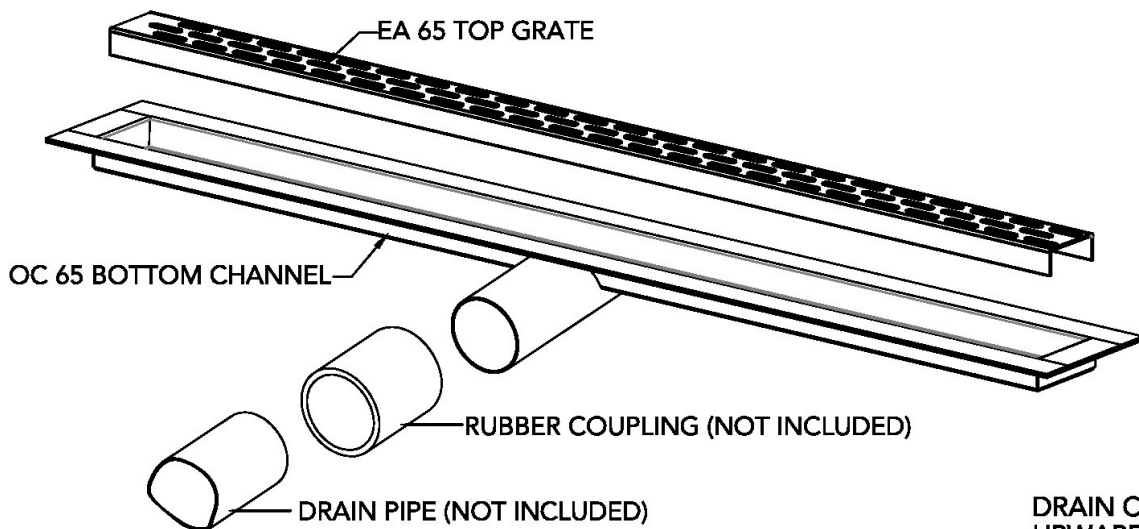
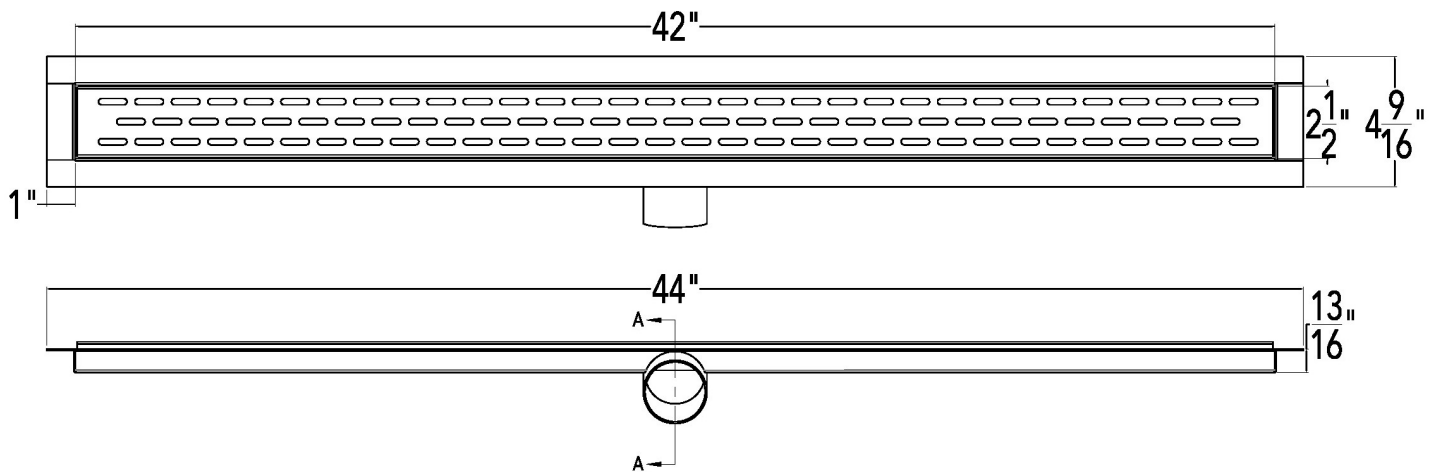

DRAIN CAN BE ADJUSTED UPWARD FOR AN ADDITIONAL 1/2" IN HEIGHT

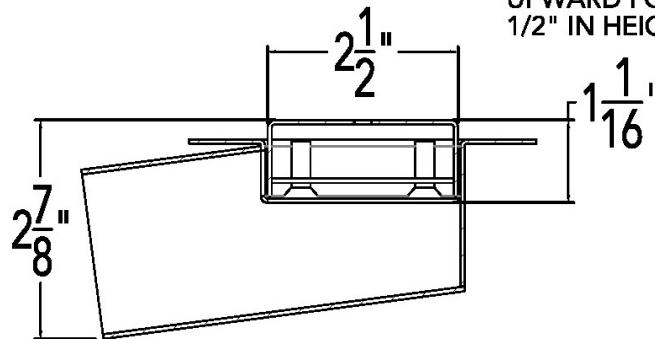

SECTION A-A

FTED 6542

42" Complete Kit Includes:

(44 1/8" l x 4 1/2" w x 1 3/16" h)

1 - EA 6542 Grate

1 - OC 6542 Fixed Flange Channel

Infinity Drain

18 Secatoag Avenue
 Port Washington, NY 11050
 Phone: 516.767.6786
 Fax: 516.740.3066
 www.InfinityDrain.com

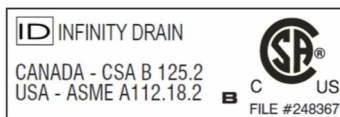

Note: Installer must verify all rough-in dimensions prior to installation and consult local and national codes. Conformity and compliance to local and national codes are the responsibility of the installer.