

FFED 65 Series

FFED 65 | Fixed Length

- 16 gauge 304 Stainless Steel grate and channel
- Pre-pitched channel with "Fixed" lengths and "Fixed" center vertical (down) outlet location
- Not site sizeable
- Indoor or outdoor use
- Bonded "Flange" installation for flush against the wall.
- Lowest height for curbless installations
- Uses Liquid and Fabric Sheet Membrane waterproofing
- Grate can be removed completely for cleaning
- Flow rate 9 GPM per outlet*

*Flow rate measured at outlet only. Measurement does not account for water in channel or sheeting on shower floor.

Finishes:

- ___ Satin Stainless
- ___ Polished Stainless
- ___ Lifetime Oil
- ___ Rubbed Bronze

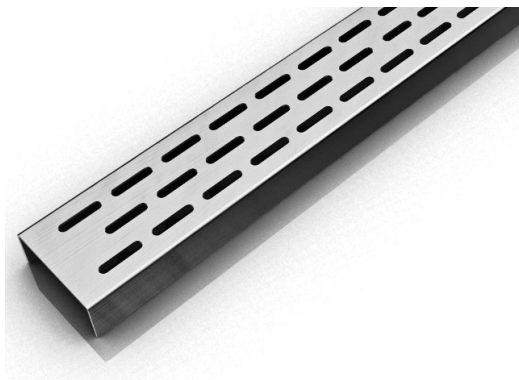

Complete Kits:

- FFED 6524 24" Complete Kit
- FFED 6532 32" Complete Kit
- FFED 6536 36" Complete Kit
- FFED 6542 42" Complete Kit
- FFED 6548 48" Complete Kit
- FFED 6560 60" Complete Kit

Components:

- EA 6524 24" Stainless Steel Grate
- EA 6532 32" Stainless Steel Grate
- EA 6536 36" Stainless Steel Grate
- EA 6542 42" Stainless Steel Grate
- EA 6548 48" Stainless Steel Grate
- EA 6560 60" Stainless Steel Grate
- FC 6532 32" Stainless Steel Fixed Channel
- FC 6536 36" Stainless Steel Fixed Channel
- FC 6542 42" Stainless Steel Fixed Channel
- FC 6548 48" Stainless Steel Fixed Channel
- FC 6560 60" Stainless Steel Fixed Channel

Installation (FF) Fixed Flange

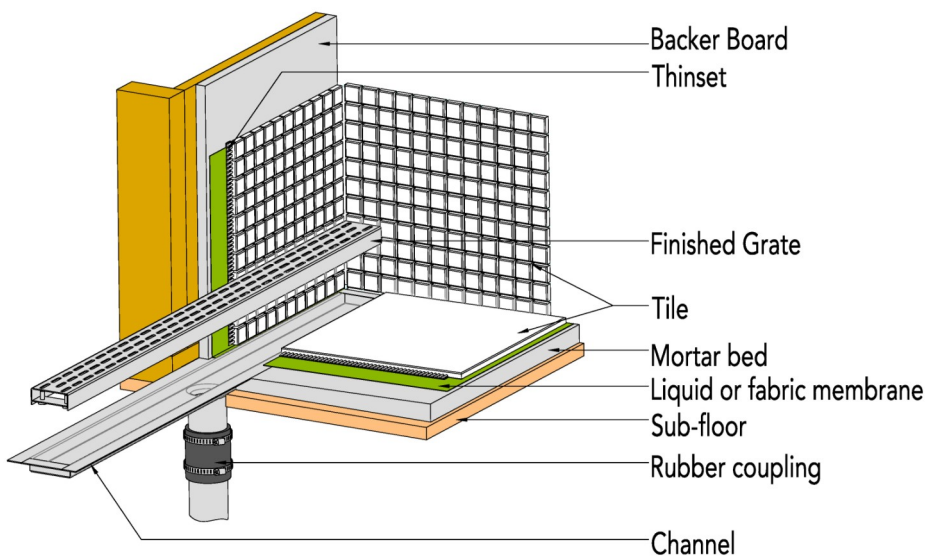

Infinity Drain

18 Secatoag Avenue
 Port Washington, NY 11050
 Phone: 516.767.6786
 Fax: 516.740.3066
 www.InfinityDrain.com

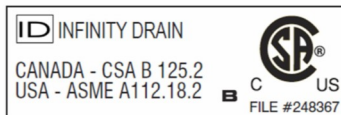

Note: Installer must verify all rough-in dimensions prior to installation and consult local and national codes. Conformity and compliance to local and national codes are the responsibility of the installer.

FFED 6560 Specifications

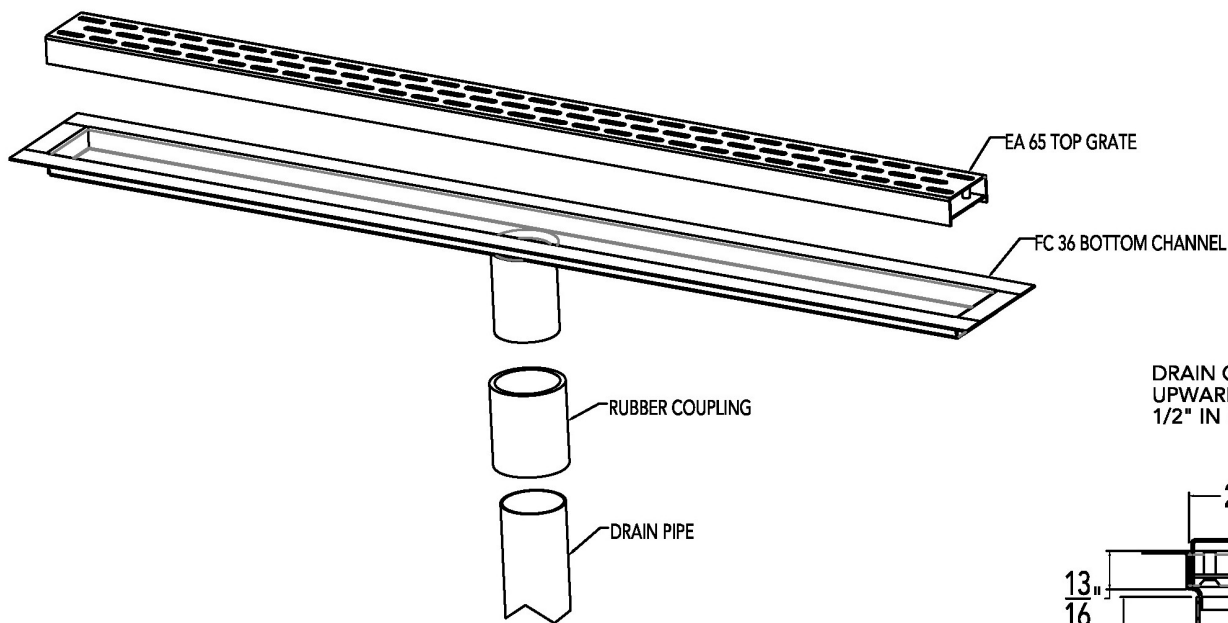
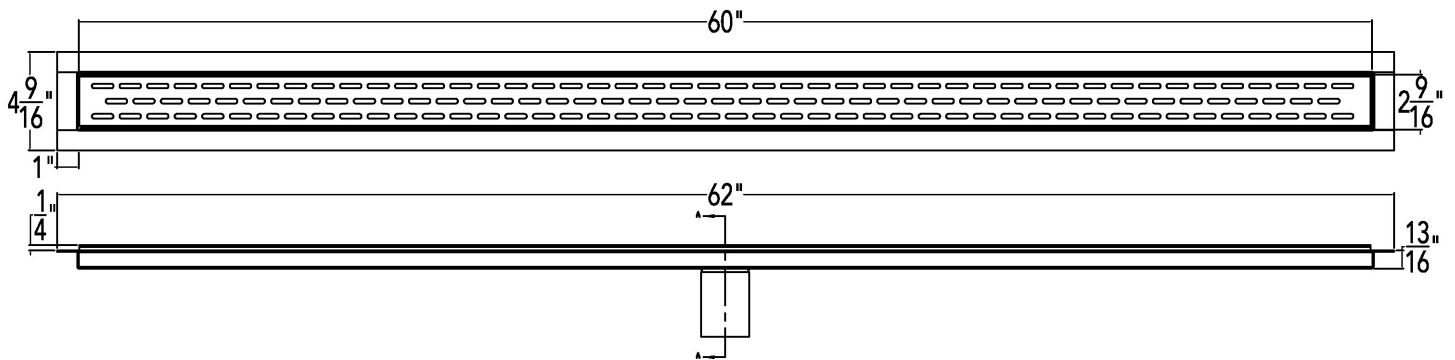

DRAIN CAN BE ADJUSTED UPWARD FOR AN ADDITIONAL 1/2" IN HEIGHT

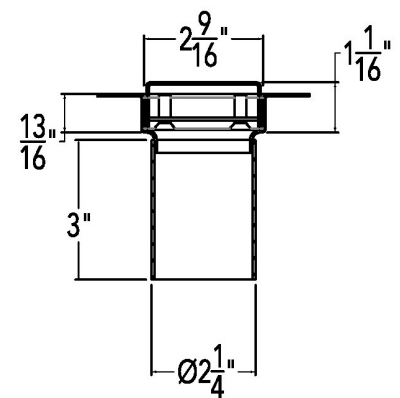

SECTION A-A

FFED 6560

60" Complete Kit Includes:

(62 1/8" l x 4 1/2" w x 4 1/16" h)

- 1 - EA 6560 Stainless Steel Grate
- 1 - FC 6560 Fixed Flange Channel

Infinity Drain

18 Secatoag Avenue
 Port Washington, NY 11050
 Phone: 516.767.6786
 Fax: 516.740.3066
 www.InfinityDrain.com

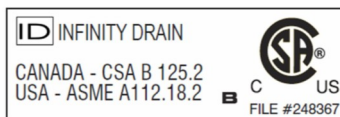

Note: Installer must verify all rough-in dimensions prior to installation and consult local and national codes. Conformity and compliance to local and national codes are the responsibility of the installer.