

S-DGAS 65 Series



S-DGAS 65 | Site Sizeable

- Modify length and locate outlet on-site
- Indoor or outdoor use
- 16 gauge, 304 perforated stainless steel grate
- Stainless Steel channel
- Works with 2" clamp down floor drain with 2" throat (strainer size) (not included)
- Uses Hot Mop, Lead Pan, PVC Vinyl Liner, Rubber Liner (Chloraloy™) Copper Pan or Fiberglass waterproofing
- Grate can be removed completely for cleaning
- Flow rate 9 GPM per outlet*

*Flow rate measured at outlet only. Measurement does not account for water in channel or sheet-

Finishes:

- Satin Stainless
- Polished Stainless

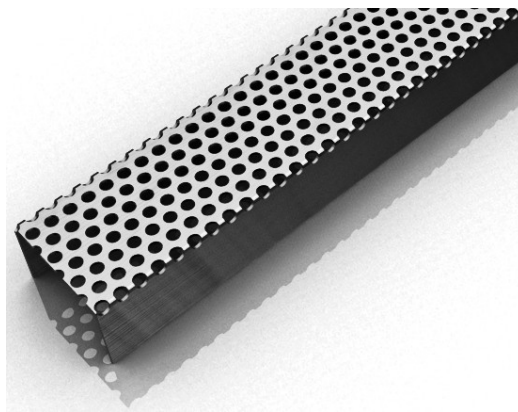

Installation (S) Site Sizable

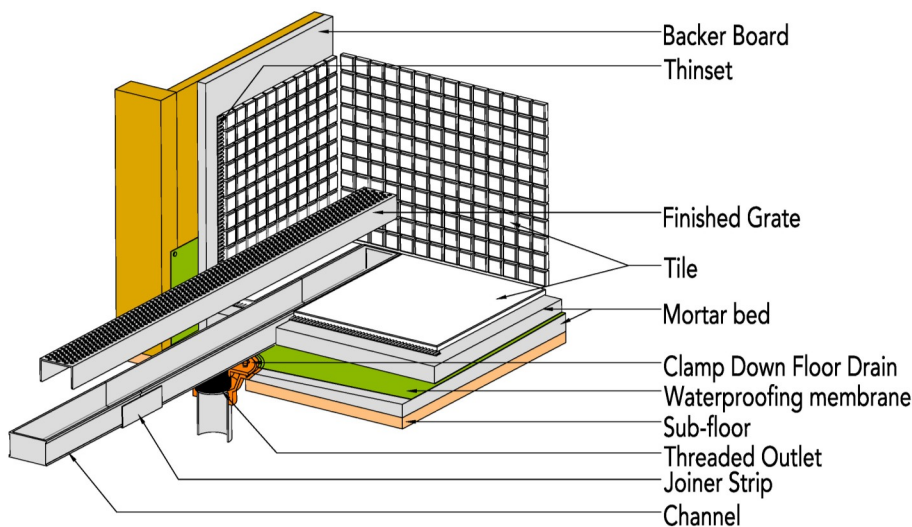

Complete Kits:

S-DGAS 6536	36" Complete Kit
S-DGAS 6548	48" Complete Kit
S-DGAS 6560	60" Complete Kit
S-DGAS 6572	72" Complete Kit
S-DGAS 6596	96" Complete Kit

Longer lengths for indoor or outdoor installations.

Components:

DA 6536	36" Stainless Steel Grate
DA 6548	48" Stainless Steel Grate
DA 6560	60" Stainless Steel Grate
SC 6548	48" Stainless Open Ended Channel
SC 6596	96" Stainless Open Ended Channel
LC 6528	28" Stainless Closed Ended Channel
LC 6540	40" Stainless Closed Ended Channel
LC 6552	52" Stainless Closed Ended Channel
LC 6564	64" Stainless Closed Ended Channel
LC 6588	88" Stainless Closed Ended Channel
LF 65	8" Stainless Steel Outlet Section
GJS 65	Stainless Steel Joiner Strip
TNAS	2" Threaded Nipple
Sikaflex	1a Construction Sealant

Add Clamp Down Drain:

CDA 22	Clamp Down Drain ABS
CDI 22	Clamp Down Drain Cast Iron
CDP 22	Clamp Down Drain PVC

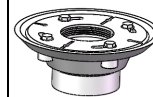

2" clamp down drain not included in kit

Optional Components:

SLA 65	Stainless Steel 90° Angle Joiner
TNRN	Stainless Steel Threaded Nipple (3" extension)
UCP 2	Universal 2" Clamping Plate
UCP 4	Universal 4" Clamping Plate
ERB	Eccentric Reducer Bushing 4" x 2"
SE 65	2" Stainless Steel End Section

Infinity Drain

18 Secatoag Avenue
Port Washington, NY 11050
Phone: 516.767.6786
Fax: 516.740.3066
www.InfinityDrain.com

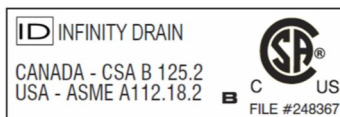

Note: Installer must verify all rough-in dimensions prior to installation and consult local and national codes. Conformity and compliance to local and national codes

S-DGAS 6536 Specifications

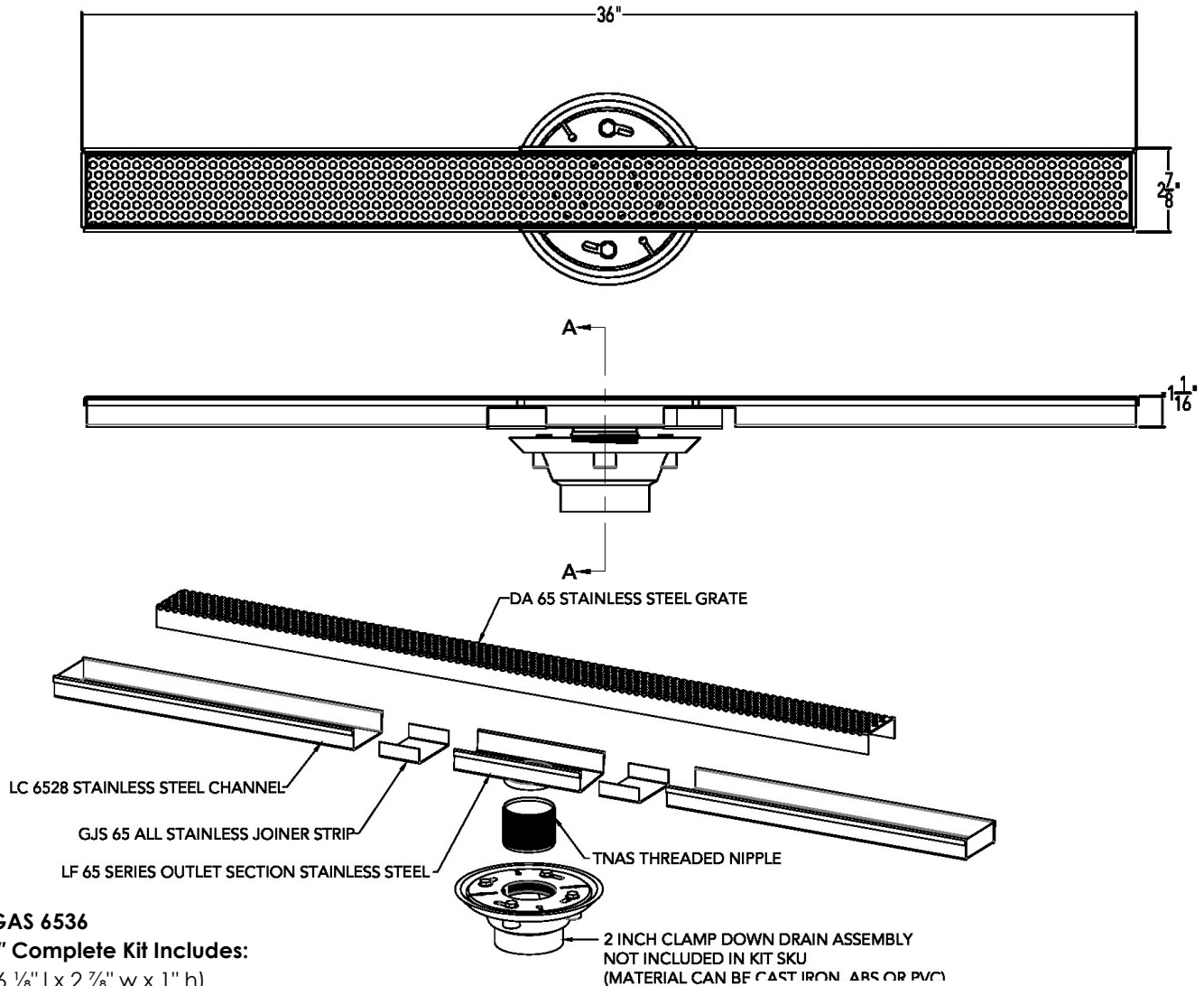

DGAS 6536

36" Complete Kit Includes:

(36 1/8" l x 2 7/8" w x 1" h)

- 1 - DA 6536 Stainless Steel Grate
- 1 - LC 6528 Stainless Steel Channel
- 1 - LF 65 8" Outlet Section Stainless Steel
- 2 - GJS 65 All Stainless Joiner Strip
- 1 - TNAS Threaded Nipple
- 1 - Sikaflex 1a Construction Sealant

Add Clamp Down Drain:

- CDA 22 Clamp Down Drain ABS
- CDI 22 Clamp Down Drain Cast Iron
- CDP 22 Clamp Down Drain PVC

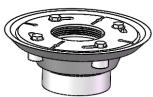

2" clamp down drain not included in kit

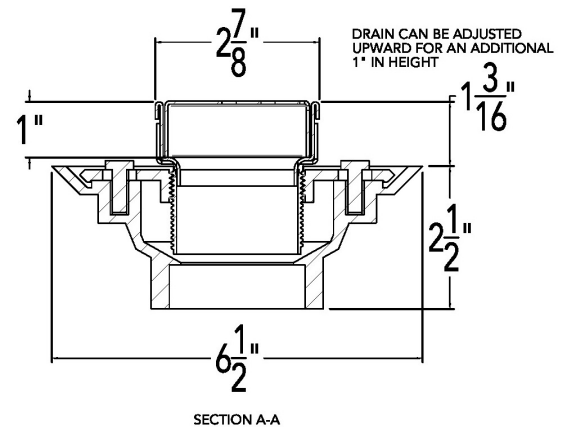

Infinity Drain
 18 Secatoag Avenue
 Port Washington, NY 11050
 Phone: 516.767.6786
 Fax: 516.740.3066
 www.InfinityDrain.com

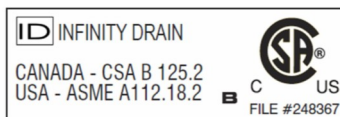

Note: Installer must verify all rough-in dimensions prior to installation and consult local and national codes. Conformity and compliance to local and national codes are the responsibility of the installer.