

S-DG 65 Series



S-DG 65 | Site Sizeable

- Modify length and locate outlet on-site
- Indoor or outdoor use
- 16 gauge, 304 perforated stainless steel grate
- PVC channel
- Works with 2" clamp down floor drain with 2" throat (strainer size) (not included)
- Uses Hot Mop, Lead Pan, PVC Vinyl Liner, Rubber Liner (Chloraloy™) Copper Pan or Fiberglass waterproofing
- Grate can be removed completely for cleaning
- Flow rate 16 GPM per outlet*

*Flow rate measured at outlet only. Measurement does not account for water in channel or sheeting on shower floor.

Finishes:

- ___ Satin Stainless
- ___ Polished Stainless
- ___ Lifetime Oil
- ___ Rubbed Bronze

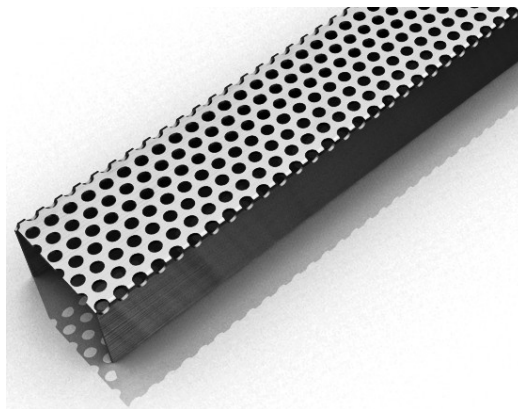

Installation (S) Site Sizable

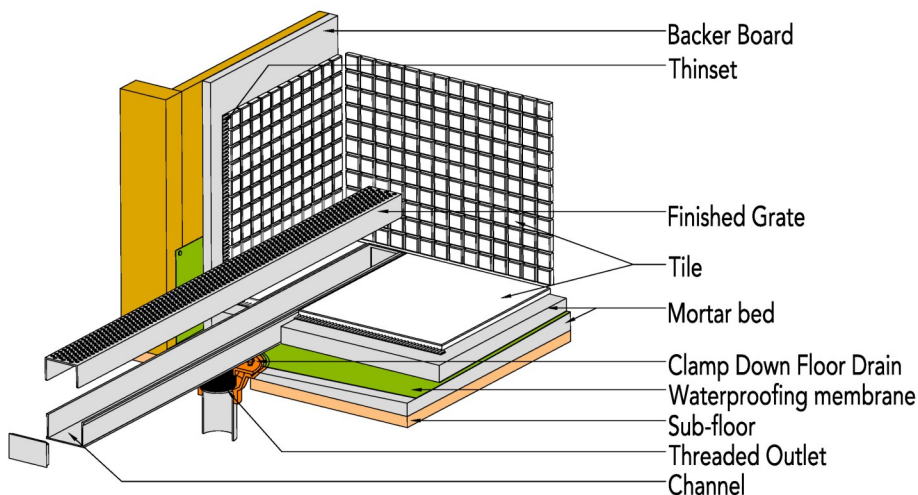

Complete Kits:

- S-DG 6548 48" Complete Kit
- S-DG 6560 60" Complete Kit
- S-DG 6596 96" Complete Kit

Longer lengths for indoor or outdoor installations.

Components:

- D 6548 48" Stainless Steel Grate
- D 6560 60" Stainless Steel Grate
- G 6536 36" PVC Channel
- G 6548 48" PVC Channel
- G 6560 60" PVC Channel
- G 6596 96" PVC Channel
- G 65108 108" PVC Channel
- E 65 PVC Stop End
- S 50 PVC Threaded Outlet

Add Clamp Down Drain:

- CDA 22 Clamp Down Drain ABS
- CDI 22 Clamp Down Drain Cast Iron
- CDP 22 Clamp Down Drain PVC

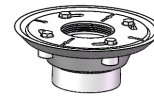

2" clamp down drain not included in kit

Optional Components:

- F 65 PVC Non-Threaded Outlet
- GJC 65 PVC Straight Joiner Strip
- GAM 65 PVC 90° Angle Joiner
- TNRN-P PVC Threaded Nipple, (extends 2 3/8" to the S 50 PVC Threaded Outlet)
- UCP 2 Universal 2" Clamping Plate
- UCP 4 Universal 4" Clamping Plate
- ERB Eccentric Reducer Bushing 4"x2"

Infinity Drain

18 Secatoag Avenue
 Port Washington, NY 11050
 Phone: 516.767.6786
 Fax: 516.740.3066
 www.InfinityDrain.com

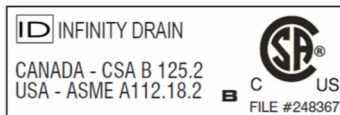

Note: Installer must verify all rough-in dimensions prior to installation and consult local and national codes. Conformity and compliance to local and national codes are the responsibility of the installer.

S-DG 6548 Specifications

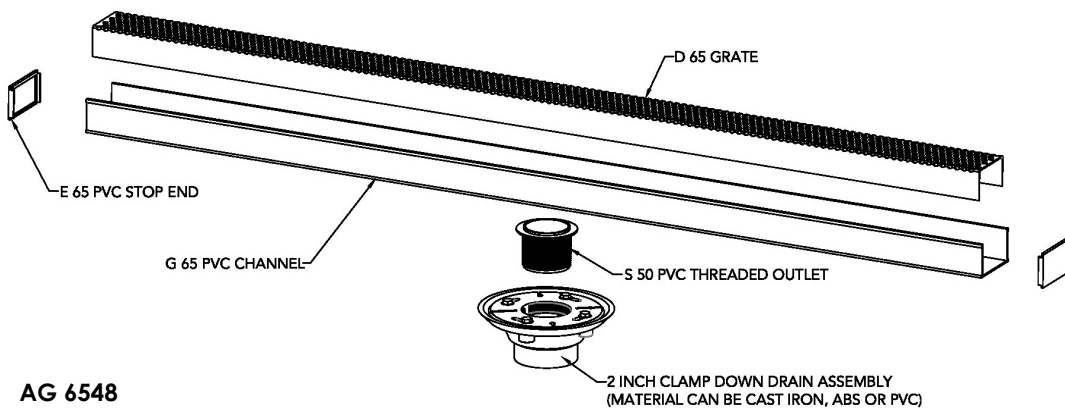
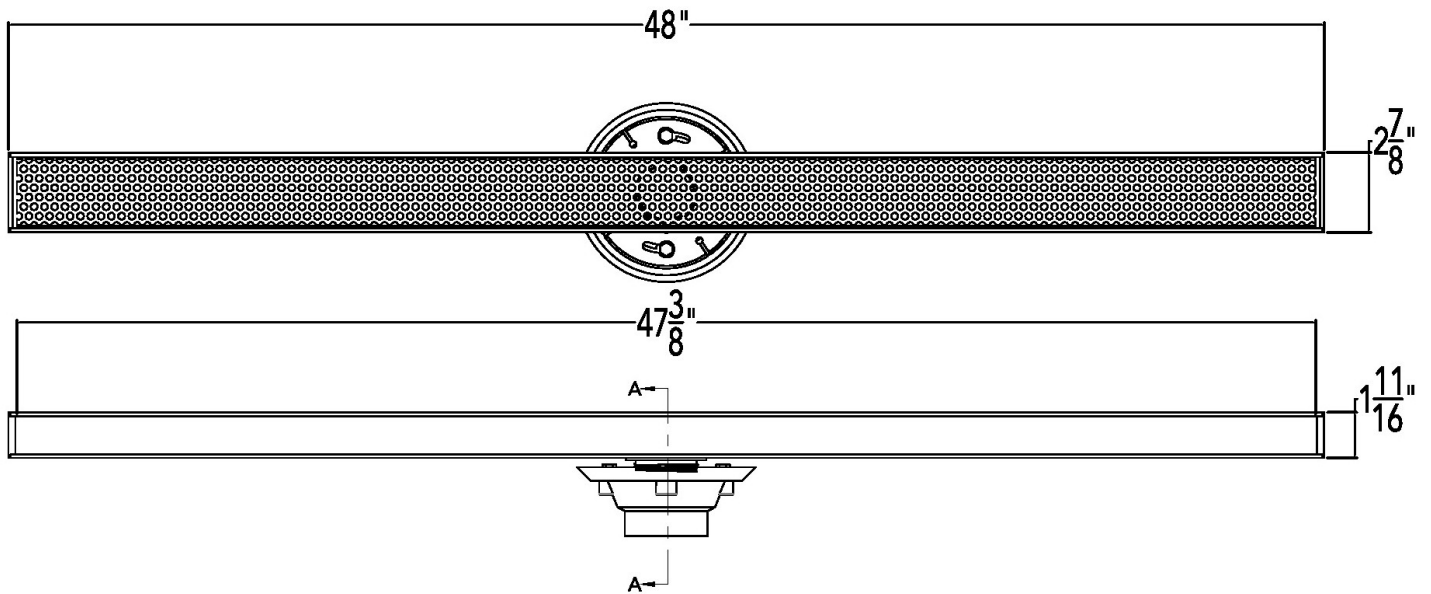

AG 6548

48" Complete Kit Includes:

- (48 1/8" l x 2 7/8" w x 1 5/8" h)
- 1 - A 6548 Stainless Steel Grate
- 1 - G 6548 PVC Channel
- 2 - E 65 End Section
- 1 - S50 Treaded Outlet

Add Clamp Down Drain:

- CDA 22 Clamp Down Drain ABS
- CDI 22 Clamp Down Drain Cast Iron
- CDP 22 Clamp Down Drain PVC

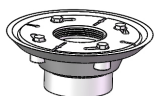

2" clamp down drain not included in kit

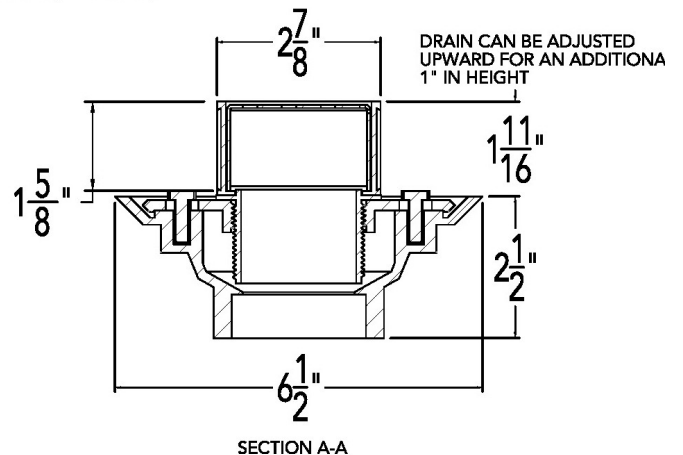

Infinity Drain
 18 Secatoag Avenue
 Port Washington, NY 11050
 Phone: 516.767.6786
 Fax: 516.740.3066
 www.InfinityDrain.com

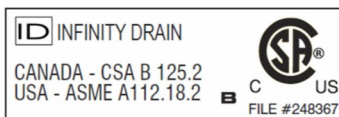

Note: Installer must verify all rough-in dimensions prior to installation and consult local and national codes. Conformity and compliance to local and national codes are the responsibility of the installer.